



MSI EQUIPMENT

www.msiequipment.net



2023 PRODUCTO

CATÁLOGO

SUS EXPERTOS # 1 EN EQUIPO DE TALLER

01

SHOP SUPPLY

Your everyday needs for any shop. From the tools, it takes to make a mess to the supplies you need to clean it up, browse our selection of commonly needed supplies. Tools, TPMS sensors, safety, abrasives, and more are at your fingertips.

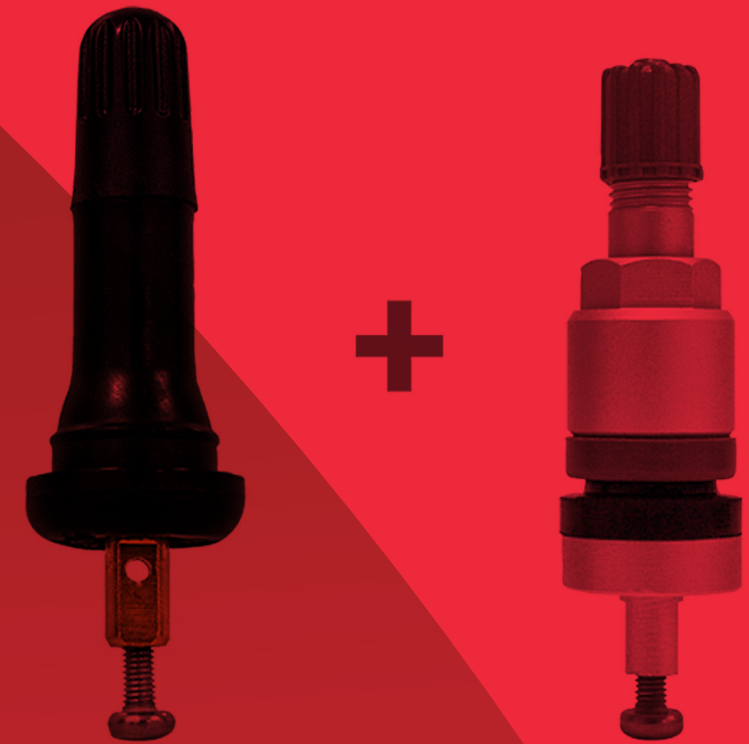

»» Safety



3M™ Comfort Grip Glove, General Use

SKU: 3M-84912

Available Sizes: M - 3M-84912
L - 3M-84911 & XL - 3M-84910



3M™ Comfort Grip Glove CGM-W, Winter

SKU: 3M-82930

Available Sizes: M - 3M-82930
L - 3M-82929 & XL - 3M-82928



3M™ Comfort Grip Glove CGM-CR, Cut Resistant (ANSI 3)

SKU: 3M-83132

Available Sizes: M - 3M-83132
L - 3M-83131 & XL - 3M-83130



3M Yellow Neons Foam Earplugs, Polyurethane, Uncorded, Regular

SKU: 3M-81250



3M Foam Earplugs, Orange, Uncorded Tapered - Box of 200

SKU: 3M-82110

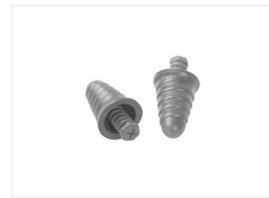

3M Next Skull Screws Earplugs, Polyurethane, Silver, Uncorded - Box of 120

SKU: 81300



3M Push-Ins Uncorded Earplugs NRR 28DB - Box of 200

SKU: 3M-81002



3M Virtua™ Protective Eyewear Clear Anti-Fog Lens, Clear Temple 20 EA/Case

SKU: 3M-80020



3M SecureFit Protective Eyewear, 200 Series, Clear, Antifog Lens

SKU: 8201AF



3M Solus 1000-Series Protective Eyewear, Clear Poly Antifog Lens - Box of 20

SKU: 3M-S1201GAF

»» Supply



3M Antifatigue Runner, Vinyl, 10 ft. x 3 ft., 1 EA

SKU: 84821



3M Cushion Mats Vinyl, 10 ft. x 3 ft., 1 EA

SKU: 84826

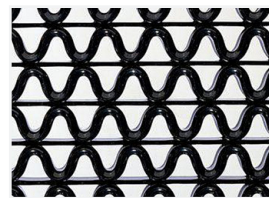

3M 3'X5' Quarry Tile Red Safe-Tigue Matting

SKU: 85978



3M™ Wheel and Tire Cleaner, 39036, 16 oz

SKU: 3M-88253



3M™ Tire Restorer, 39042, 16 oz

SKU: 3M-86181



3M™ Petroleum Sorbent Mini-Pillow T-30, 16 Each/Case

SKU: 3M-81409



3M™ Petroleum Sorbent Pad, High Capacity, Case of 100

SKU: 3M-85048



Scott® Shop Towel Rolls

SKU: 89901



Shop Towel Rolls 11 x 9.4" Roll Diameter: 4.4

SKU: 89900

»» TPMS



Hamaton H47 TPMS Tool with OBDII and 20 U-Pro Hybrid Sensors (Bundle) - Snap-in Valve

SKU: HAM-B034

New H47 TPMS Tool with OBDII and 20 U-Pro Hybrid Sensors (Bundle) - Snap-in Valve. Comes with 20 sensors

Interchangeable Part Numbers:
H47 Unit Only - 72-20-680

MT-RSR Insights:
The H47 packs an abundance of features, including integrated OBDII module into a compact, ergonomic design.



Hamaton H47 TPMS Tool with OBDII and 12 U-Pro Hybrid Sensors (Bundle) - Snap-in Valve

SKU: HAM-B030

New H47 TPMS Tool with OBDII and 12 U-Pro Hybrid Sensors (Bundle) - Snap-in Valve. Comes with 12 sensors

Interchangeable Part Numbers:
H47 Unit Only - 72-20-680

MT-RSR Insights:
The H47 packs an abundance of features, including integrated OBDII module into a compact, ergonomic design.

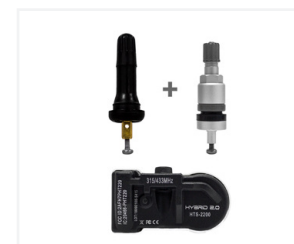

Hamaton Hybrid 2.0 Dual Valve Dual-Frequency TPMS Sensor

SKU: HAM-A66DD

Dual Valve U-Pro 2.0 Hybrid Dual Band 315-433 - Programmable/Configurable Technology. Compatible With: 97% of direct TPMS-enabled vehicle coverage with 100% potential due to continual programmable updates

Interchangeable Part Numbers:
21360, 5624132

MT-RSR Insights:
The only single SKU solution. Configure and program sensor in 1-3 and 7-10 seconds respectively - the fastest times on the market.



Hamaton TPMS Replacement Sensor HTS-A66DG

SKU: HAM-A66DG

The only dual frequency, configurable and programmable TPMS sensor. 97% of direct TPMS-enabled vehicle coverage with 100% potential due to continual programmable updates.

Interchangeable Part Numbers:
5624128, PREM-ONE

MT-RSR Insights:
Nut Torque: Snap-In
Screw Torque: 12.39in-lbs



Hamaton TPMS Starter Kit 6-352, Contains 64 Service Kits

SKU: HAM-6352

This TPMS Starter Kit contains four (4) each of the following sensor service kits: 6-102, 6-108, 6-109, 6-116T, 6-120, 6-127, 6-138, 6-139, 6-211, 6-207, 6-208, 6-210H, 6-201, 6-228, 6231C, 6-240



Hamaton Tool Kit and Carry Case

SKU: HAM-6313

This TPMS Tool Kit comes complete with: Calibrated Torque Tool including: 7mm Hex Socket, 11mm Hex Socket, 12mm Hex Socket, Torx 10 Bit, Torx 15 Bit, Torx 20 Bit, Valve Core Torque Tool, Grommet Removal Tool & T6 Torx Screwdriver,

Interchangeable Part Numbers:
72-20-711, 5628538

MT-RSR Insights:
Hamaton's Starter Kits meet the needs of garages and tire bays who service valves, as they contain a comprehensive range of OE and aftermarket replacement parts.

MT-RSR Insights:
This TPMS Tool Kit contains all of the workshop tools required for servicing or replacing TPMS sensors.

Snap-In

Clamp-In

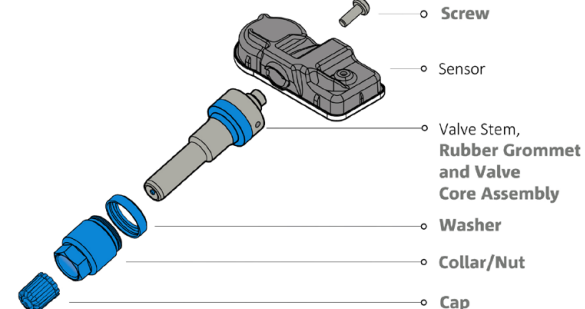
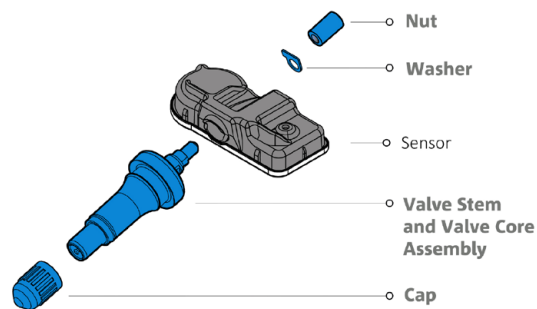

Components that require replacement when servicing sensors are highlighted above in blue.

© 2019 Hamaton Valves and Accessories Catalogue



Hamaton Snap-in Valve for U-Pro Hybrid 2.0

SKU: HAM-6207

Interchangeable Part Numbers:
6-207, 72-20-401, 5628461, 21060, 5026, 20018, VS-950, 5628491, 591320, 92-0145



Chrome Snap-in Valve Stem 10/Box

SKU: HAM-6207C

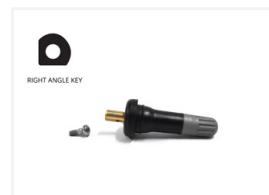

Hamaton TPMS Service Kit 6-210, Pack of 10, Schrader Snap-In Sensor

SKU: HAM-6210

These valves are suitable for use with Schrader Snap-In Sensors. A box of 10 snap-in valves, each include: 1 valve stem, 1 screw and 1 valve cap.

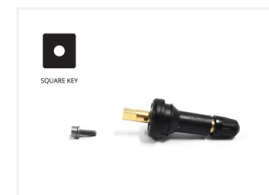

Hamaton TPMS Service Kit 6-211, Pack of 10, TRW Version 4 sensor

SKU: HAM-6211

Interchangeable Part Numbers:
72-20-437, 21636, 20635, VS-65, 5628534

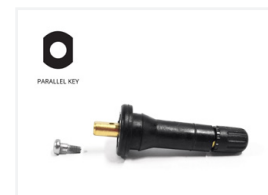

Hamaton TPMS Service Kit 6-213, Pack of 10, Schrader Rev 4

SKU: HAM-6213

Interchangeable Part Numbers:
72-20-470, 21774, 5036



Box of 10 Replacement Snap-in Valves for Cub/Smart Sensor 17-43016

SKU: HAM-6215A



Hamaton TPMS Service Kit 6-216, Pack of 10, Schrader Rev 4

SKU: HAM-6216

Interchangeable Part Numbers:
72-20-448, 5628489, 21051, 5024, 66086-67, VS-925A



Hamaton TPMS Service Kit 6-218, Pack of 10, VDO MB

SKU: HAM-6218

Interchangeable Part Numbers:
72-20-445, 21038, 5015, 1098K, 591322



Hamaton TPMS Service Kit 6-201, Pack of 10, VDO TG1B

SKU: HAM-6201

Interchangeable Part Numbers: 72-20-453, 5628496, 21765



Hamaton TPMS Service Kit 6-231C, Pack of 10

SKU: HAM-6231C

Interchangeable Part Numbers:
72-20-482, 5628580, 21117, 5628475, VS-70, 591326



High Speed Dual Fitment Clamp-in Valve for U-Pro Hybrid 2.0

SKU: HAM-6266

Interchangeable Part Numbers:
21707UP, 34000



Hamaton Black High Speed Dual Fitment Clamp-in Valve for U-Pro Hybrid 2.0 (10 Pack)

SKU: HAM-266BK

Interchangeable Part Numbers:
21707UP, 34000



Hamaton TPMS Replacement Valve 6-503, Pack of 10

SKU: HAM-6503

Interchangeable Part Numbers:
72-20-481, 5628748

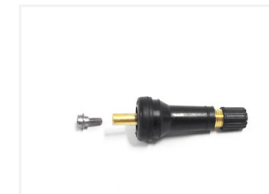

Hamaton TPMS Replacement Valve 6-507, Pack of 10

SKU: HAM-6507

A box of 10 snap-in valves, with each including 1 valve stem, and 1 valve cap.



Hamaton TPMS Service Kit 6-208, Pack of 10, VDO TG1D

SKU: HAM-6208

Interchangeable Part Numbers:
72-20-440, 5628741, 21761, 20043, VS-90



Box Of 10 Short Snap-in Valves for Schrader Gen 4

SKU: HAM-TPS412

Interchangeable Part Numbers:
17-50398 TPMS 412



Autel MX Sensor Rubber Valve Stem - 4PK

SKU: MX-Sensor

Fits: Autel MX-Sensors.



Hamaton TPMS Service Kit 6-102, Pack of 10, Schrader Gen J

SKU: HAM-6102

Interchangeable Part Numbers:
72-20-523, 20004, 5030, 1070K, 591303, 92-0125

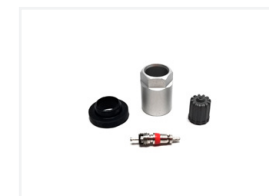

Hamaton TPMS Service Kit 6-103, Pack of 10, Schrader Gen 2/3

SKU: HAM-6103

Interchangeable Part Numbers:
72-20-564, 20003, 1080K, 591304, 92-0140

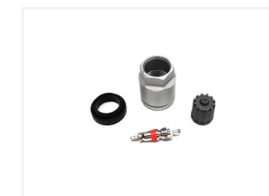

Hamaton TPMS Service Kit 6-104, Pack of 10, Schrader Gen 2/3

SKU: HAM-6104

Interchangeable Part Numbers:
72-20-565, 20002, 1060K, 591302, 92-0115



Hamaton TPMS Service Kit 6-108, Pack of 10, VDO TG1B

SKU: HAM-6108

Interchangeable Part Numbers:
72-20-550, 21102, 20030, 1050K, 591301, 92-0150



Hamaton TPMS Service Kit 6-109, Box of 10, HUF Gen 2 Sensor

SKU: HAM-6109

Interchangeable Part Numbers:
72-20-551, 21032, 20021, 2000K, 591309, 92-0246



Hamaton TPMS Service Kit 6-110, Pack of 10, HUF Sensor

SKU: HAM-6110

Interchangeable Part Numbers:
72-20-520, 5628454, 21106, 20023, 1090K, 591305, 92-0261



Hamaton TPMS Service Kit 6-111, Pack of 10, Huf Gen 2 Sensors

SKU: HAM-6111

Interchangeable Part Numbers:
72-20-552, 21029, 20032, 1100K, 591306, 92-0215



Hamaton TPMS Service Kit 6-112, Pack of 10, Schrader Gen 2/3

SKU: HAM-6112

Interchangeable Part Numbers:
72-20-553, 20005, 1130K, 591308, 92-0130



Hamaton TPMS Service Kit 6-115, Pack of 10, VDO TG1B

SKU: HAM-6115

Interchangeable Part Numbers:
72-20-506, 5628419, 21027, 5007, 65660-KD, 20017, 1030K, 591318, 92-0235



Hamaton TPMS Service Kit 6-116T, Pack of 10 Pacific LFB1/LFC1

SKU: HAM-6116T

Interchangeable Part Numbers:
72-20-525, 21030, 20031, 1110K, 5628533, 591307, 92-0135



Hamaton TPMS Service Kit 6-117, Pack of 10, Pacific LFB1/LFC1

SKU: HAM-6117

Interchangeable Part Numbers:
72-20-555, 21031, 20033, 1120K, 591314, 92-0155



Hamaton TPMS Service Kit 6-118, Pack of 10, Schrader Gen 2/3

SKU: HAM-6118

Interchangeable Part Numbers:
72-20-504, 5628405, 20010, 5004, 65657-KD, 2010K, 6-118F



Hamaton TPMS Service Kit 6-120, Pack of 10, Schrader Gen Alpha

SKU: HAM-6120

Interchangeable Part Numbers:
72-20-557, 21037, 20014, 2030K, 591312, 92-9210



Hamaton TPMS Service Kit 6-122, Pack of 10, Schrader Gen J

SKU: HAM-6122

Interchangeable Part Numbers:
72-20-558, 20009, 2010K, 591310, 92-0195



Hamaton TPMS Service Kit 6-125, Pack of 10, TRW Sensors

SKU: HAM-6125

Interchangeable Part Numbers:
72-20-560, 21036, 20015, 2020K, 591311, 92-0220, 92-0190

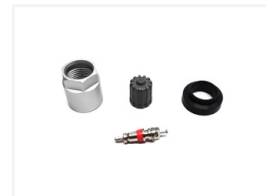

Hamaton TPMS Service Kit 6-127, Pack of 10, TRW Version 1

SKU: HAM-6127

Interchangeable Part Numbers:
72-20-561, 21138, 20019, 2040K, 591313, 92-0244



Hamaton TPMS Service Kit 6-129, Pack of 10, VDO TG1B

SKU: HAM-6129

Interchangeable Part Numbers:
72-20-562, 21206, 20017, 1031K, 591317



Hamaton TPMS Service Kit 6-138, Pack of 10, VDO TG1C

SKU: HAM-6138

Interchangeable Part Numbers:
72-20-513, 5628447, 21111, 66070-KU, 7020K, 5628421, 591315, 92-3312

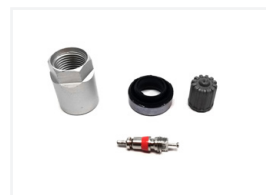

Hamaton TPMS Service Kit 6-139, Pack of 10, VDO TG1C

SKU: HAM-6139

Interchangeable Part Numbers:
21113, 7000K, 5628458, 591316, 92-3311



Nickel Plated TPMS Valve Cores - Red Teflon Seal (Pack of 100)

SKU: HAM-114001

Interchangeable Part Numbers:
1-1400, 72-20-512, 42321-69



Brass Red Teflon Sealing Valve Cores (Pack of 100)

SKU: HAM-114004

High Temp Valve Core - Rated To 200psi. Not for use in TPMS stems!

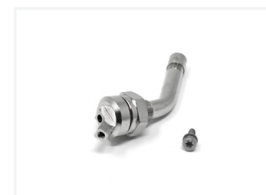

Replacement Angled Clamp-In Valve for TRW Sensors Pack of 10

SKU: HAM-1502C

Barcode: 6924478982955
Comparative Part Numbers: TR543C
Length: 58.5



Long Black TPMS Valve Caps - 100/Box

SKU: HAM-2158

Interchangeable Part Numbers:
HAM-6207, 20008, 20018



Metal Valve Cap, Nickel Plated (Pack of 100)

SKU: HAM-2101



Standard TPMS Valve Caps, Grey (Pack of 100)

SKU: HAM-2128



Plastic Cap, With Rubber Grommet, Green (Pack of 100)

SKU: HAM-2105D3

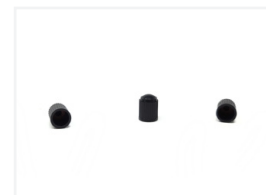

500 Black Plastic Valve Caps 500/box

SKU: X17492-500

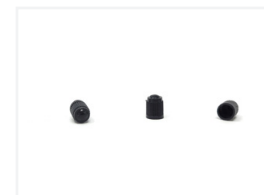

Black Plastic Valve Caps 100/box

SKU: X17492



TR412

TR413

TR414

TR418

TR415

TR413AC

TR414C

MT-RSR Part #	Description	Length	Schrader		Xtra-Seal		Dill	
			EA	50/Box	500/Box	50/Box	500/Box	500/Box
TR412	TR412 Snap-in Rubber Tire Valve	7/8"	SCV412	SCV412-50	SCV412-500	XSC412-50	XSC412-500	
TR413	TR413 Snap-in Rubber Tire Valve	1-1/4"	SCV413	SCV413-50	SCV413-500	XSC413-50	XSC413-500	DILV413-500
TR414	TR414 Snap-in Rubber Tire Valve	1-1/2"	SCV414	SCV414-50	SCV414-500	XSC414-50	XSC414-500	DILV414-500
TR418	TR418 Snap-in Rubber Tire Valve	2"	SCV418	SCV418-50	SCV418-500	XSC418-50	XSC418-500	DILV418-500
TR415	TR415 Snap-in Rubber Tire Valve	1-1/4"	SCV415	SCV415-50	SCV415-500	XSC415-50		DILV415-500
TR413AC	Chrome TR413 Snap-in Tire Valve	1-1/4"						
TR414C	Chrome TR414 Snap-in Tire Valve	1-1/2"						

»» TPMS - Tools



»» Socket - Tools



1/2" Drive 5-Piece 1/2 Size Flip Socket Set

SKU: 10-12051

Interchangeable Part Numbers:
167-12051



1/2" Drive x 17mm Extra Thin Wall Impact Socket

SKU: 10-1017MDT

Interchangeable Part Numbers:
167-10172



1/2" Dr. x 18.5mm x 19.5mm Deep Flip Impact Socket

SKU: 10-18195

Interchangeable Part Numbers:
167-18195



1/2" Dr. x 19mm x 21mm Deep Flip Impact Socket

SKU: 10-1291D

Interchangeable Part Numbers:
167-12912



1/2" Dr. x 19mm x 21mm Deep Flip Impact Socket - Thin Wall

SKU: 10-1291DT

Interchangeable Part Numbers:
167-12912



1/2" Dr. x 21mm x 21.5mm Deep Flip Impact Socket

SKU: 10-21215

Interchangeable Part Numbers:
167-21215



1/2" Drive x 22mm x 22.5mm Deep Flip Impact Socket

SKU: 10-22225

Interchangeable Part Numbers:
167-22225



1/2" Dr. x 3/4" x 13/16" Deep Flip Impact Socket

SKU: 10-1246D

Interchangeable Part Numbers:
167-12460



1/2" Dr. x 3/4" x 13/16" Deep Flip Impact Socket - Thin Wall

SKU: 167-12461

Interchangeable Part Numbers:
167-12461



1/2" Dr. x 3/4" x 13/16" Deep Thinwall Flip Socket

SKU: 10-1246DT

Interchangeable Part Numbers:
167-12461



17MM Twist Socket

SKU: 10-TS17MM



19MM Twist Socket

SKU: 10-TS19MM



21MM Twist Socket

SKU: 10-TS21MM



5 Piece 1/2" Drive Twist Socket Set

SKU: 10-TSKIT



Cal-Van Tools Wheel Stud-Cleaner

SKU: CAL-16



AETEO Twist Socket Set

SKU: 10-TSAETEO



Mueller-Werkzeug Inner Rim Cleaner Tool Replacement Discs 3-Pieces

SKU: 433508



Mueller-Werkzeug Inner Rim Cleaner Tool

SKU: 433507



ESCO Stud Kleen Stud and Wheel Cleaner

SKU: ESC-50170



3 Pcs Spline-Plus Socket Set

SKU: 67800

MT-RSR Insights: The AETEO Twist Socket Set was designed to loosen any nut or wheel lug which cannot be loosened using a standard socket or lug wrench. This tool can remove security nuts and lugs, in addition to damaged nuts or lugs. Due to the unique twist pattern inside the socket, this tool is only useful for a nut or lug with positive threads.



Grey Torque Wrench

SKU: 10-0308



Torque Wrench Kit

SKU: 22216282



7-pc 1/2" Drive Torque Extension Set

SKU: 10-3350



3-Pc 1/2" Drive Spline With Protective Sleeve Socket Set

SKU: 10-3303

MT-RSR Insights: The 7-pc 1/2" Torque Extensions Set is for use with thin wall impact sockets. Prevent over-torque of wheel nuts. Use with foreign or domestic cars and light trucks. The complete set comes in a handy plastic case, suitable for travel.

»» Wheel Weights - Tools



18141 Hub Cap Hammer



GP-1470R GP Standard Wheel Weight Tool



WWH-36 Premium Wheel Weight Hammer/Plier



HAM-3121A Heavy Duty Wheel Weight Pliers



HAM-3122 No-Mark Wheel Weight Hammer/Pliers for Aluminum



HAM-121B Wheel Weight Hammer/Pliers, Black



T139 Wheel Weight Tool

»» Abrasives



#	MT-RSR Part Number	Description	Interchangeable Part Number:
1	3M-05527	Scotch-Brite™ Roloc™ 05527 Surface Conditioning Disc - Maroon - Medium - 2in - TP - 50 per box	
2	3M-05531	Scotch-Brite™ Roloc™ 05531 Surface Conditioning Disc - Maroon - Medium - TR - 3in - 25 per box	
3	3M-07485	Scotch-Brite™ Roloc™ 07485 Surface Conditioning Disc - Brown - Coarse - TR - 3 in - 25 per box	
4	3M-07480	Scotch-Brite™ Roloc™ 07480 Surface Conditioning Disc - Brown - 2 in - Coarse - TR - 25 per box	
5	S-13062	2" Star-Brite Superior Life Discs – Coarse Brown (Pack of 50)	07480,13003, Mi197
6	S-630TB	3" Surface Conditioning Disc Coarse Brown, Box of 50	0785, Mi17
7	S-632TB	3" Surface Conditioning Disc Medium Maroon, Box of 50	07486, 05531, Mi27
8	S-12614	2" Green Zirconia 50 Grit Surface Conditioning Disc (Box of 25)	3M-01396, MI306
9	3M-81396	3M Green Corps Roloc Discs, Aluminum Oxide, 2 in Dia., 50 Grit, 3M (each)	3M #01396
10	S-13243	2" Blue Zirconia 36 Grit Disc. Box of 50	MI203
11	S-43221	2" Aluminum Oxide Surface Conditioning Discs 36 Grit (Box of 50)	MI215
12	S-622TB	2" Surface Conditioning Disc Medium Grit Maroon (Box of 50)	05527, 07481, Mi297
13	3M-89790	3M Utility Cloth Rolls 314D, 1 in x 50 yd, P120 Grit	3M #19790
14	3M-89792	3M Utility Cloth Rolls 314D, 1 in x 50 yd, P80 Grit	3M #19792
15	3M-84209	3M Scotch-Brite Hand Pads, #7447 PAD	3M #7447
16	3M-84780	3M Scotch-Brite Clean and Strip Buffing Discs, 4 in, 8,000 rpm, Black/Gray	3M #14780
17	3M-21713	Scotch-Brite Roloc Hub Cleaning Disc, 1-1/2" X 5/8", 10/Box	
18	3M-07528	2" Bristle Disc White, 120 Grit 10 PK	
19	3M-07525	2" Bristle Disc Yellow, 80 Grit 10 PK	
20	3M-07524	2" Bristle Disc Green, 50 Grit 10 PK	
21	42705	Cut Off Wheel 3" X 1/16", AH 3/8" Box of 50	Shark: 12705, BOOIR9KG
22	42711	Cut Off Wheel 4" X 1/32", AH 3/8" Box of 50	Shark: 12711
23	44164	3" Encapsulated Wire Wheel	Shark: 14164, Weiler: 35250
24	44060	4" Twisted Wire Wheel With 3/8" Hole, 20,000 RPM	Shark: 14060
25	S-14165	3" Twisted Wire Wheel	
26	85096	3M 2" Hard Disc Pad	3M #45096
27	10-1320	2" Surface Prep Holder with 1/4" Shank	KTI-71320
28	10-1321	3" Surface Prep Holder with 1/4" Shank	KTI-71321
29	85102	3M 1/4" SHANK	3M# 45102
30	3M-07545	3M™ Brake Hub Cleaning Disc Holder 07545	
31	3M-28341	Disc Sander 28341, 2 in .3 HP 20, 000 RPM	3M #20231
32	3M-88547	3M 3" Disc Sander Pistol Grip 0.45 hp motor	3M #28547

»» Tire Repair Tools

SKU: HAM-100	SKU: HAM-105	SKU: HAM-145	SKU: HAM-155	SKU: HAM-165	SKU: HAM-240	SKU: DY-1887	SKU: DY-5099	SKU: HAM-HT190C	SKU: VTO3S
Interchangeable Part Numbers: D-7229USA M-S917 X-909C	Interchangeable Part Numbers: D-7213USA M-S921 X-910C	Interchangeable Part Numbers: D-5600 M-S925 X-912	Interchangeable Part Numbers: D-7125H M-S986C X-1045C	Interchangeable Part Numbers: D-7262 M-986BLK X-1045BC	Interchangeable Part Numbers: D-7226H X-like the 911S				



Wood Handled Stitcher, 51mm Diameter, 4mm Thickness

SKU: HAM-31027



Xtra Seal 3/16" x 1 1/2" Wood Handle Ball Bearing Stitcher

SKU: X14314



Plastic Handled Stitcher, 38mm Diameter, 3mm Thickness

SKU: HAM-31021



Xtra Seal Flexible Skiving Knife

SKU: X14305



Flexible Skiving Knife

SKU: HAM-3154A



Xtra Seal Screwdriver Handle Power Awl

SKU: X14310



Power-Awl

SKU: HAM-4110



Valve Stem Remover

SKU: 18147



Valve Stem Remover Long

SKU: 18147L



Two Headed Valve Stem Remover

SKU: TI60



Xtra Seal Quick Change Adapter, 5/8" x 3/8" threads

SKU: X14330



Xtra Seal Quick Change Adapter w/ Spacer, 1" x 3/8" threads

SKU: X14331



Xtra Seal Quick Change Adapter for 3/16" shank

SKU: X14333



Xtra Seal Quick Change Adapter for 1/4" shank

SKU: X14334

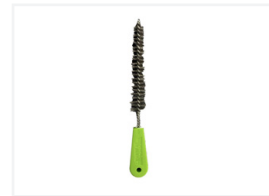

10" Valve Stem Hole Brush

SKU: VIMBS1



Xtra Seal XLIGHT Clamp-On LED Work Light

SKU: X14923



Xtra Seal Small Brass Sidewall Tire Brush

SKU: X14301



Single Edge Razor Blades .009 100 per box

SKU: 66-0089



Pistol-Grip with Closed-Eye Needle (No 6)

SKU: HAM-4202N06



Xtra Seal Pistol-Grip Spiral Cement Probe

SKU: X14204



Xtra Seal Die-Cast T-Handle Spiral Cement Probe

SKU: X14218

Interchangeable Part Numbers:
167-12461



Cable-Type Valve Fishing Tool, 8 Inch Length

SKU: HAM-3113



14 in. Straight-On Tilt Lock Dual Foot Chuck (Closed)

SKU: HAM-333-LO

Interchangeable Part Numbers:
D-6174FT M-693-12Group
X-6568L



Premium 14" Straight-On Tilt Lock Dual Foot Chuck Closed

SKU: HAM-355-LO

Interchangeable Part Numbers:
D-6568USA M-693-12Group not
BLK X - 6568BL



14in. Close Chrome Straight-On Tilt Lock Chuck

SKU: 6568LC

Interchangeable Part Numbers:
6568L, Ti6847



300 Series Die Grinders 0.25 HP, 1/4 in; 6.00 mm, 21,000 rpm, 1/4 hp

SKU: 83301B



300 Series Die Grinders 0.33 HP, 1/4 in NPT(F); 6.00 mm, 20,000 rpm, 0.33 hp

SKU: 83302B



302 Series Die Grinders 0.25 HP, 1/4 in NPT(F); 6.00 mm, 28,000 rpm, 1/4 hp

SKU: 83307B



301 Series Die Grinders 0.33 HP, 1/4 in NPT(F); 6.00 mm, 25,000 rpm, 0.33 hp

SKU: 83308B



Heavy Duty 1/2" HP 1/4" Straight Die Grinder

SKU: 87124



Dual Head Core Removal Tool

SKU: 10-4456



Valve Core Remover Tool, Double End, Red

SKU: HAM-3107

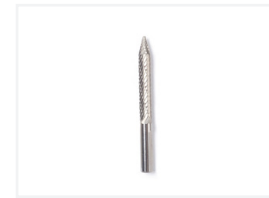

Xtra Seal 3/16" Carbide Cutter

SKU: X14345

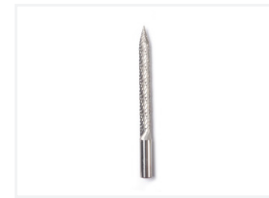

Xtra Seal 7/32" Carbide Cutter

SKU: X14346



Xtra Seal 13/32" Carbide Cutter

SKU: X14348



Plastic Handle Hole Fitting Brush 1/2" X 6-1/2"

SKU: S-14017



Tire Scraper

SKU: MI160



Xtra Seal Hoe Style Inner Liner Scraper

SKU: X14315H



Contour Wheel with adapter 55MM 2 3/16"

SKU: 10-4479



Hub Cap Rubber Head Hammer And Plier

SKU: 10-31568



Zinc-Alloy T-Handle with Spiral Probe (No 1)

SKU: HAM-4209N01



Split Eye Needle T-Handle with Stop

SKU: 10-4463



Metal T-Handle Spiral Probe

SKU: 10-4401



Chain-Type Valve Fishing Tool, 8 Inch Length

SKU: HAM-3112



4-Way Valve Tool, Brushed Finish

SKU: HAM-3108



6.5 in. Straight-On Tilt Lock Dual Foot Chuck (Closed)

SKU: HAM-330-LO

Interchangeable Part Numbers:
D-6568USA M-693-12Group
not BLK X - 6568BL



6.5 in. Premium Straight-On Tilt Lock Dual Foot Air Chuck (Closed)

SKU: HAM-350-LO

Interchangeable Part Numbers:
D-6175USA M-693BLK X-6568BC

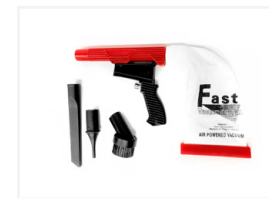

Xtra Seal Quick Spiff Air Powered Vacuum with attachments

SKU: X14399

Interchangeable Part Numbers:
167-12461



Quick Spiff Air Powered Vacuum (Vacuum Only)

SKU: X143991

02

WHEEL ALIGNMENT

Systems and spare parts to align wheels on cars, trucks, and trailers. We make our wheel clamps in house, as well as many of our accessories. The Tru-Line alignment systems are also 100% USA made.

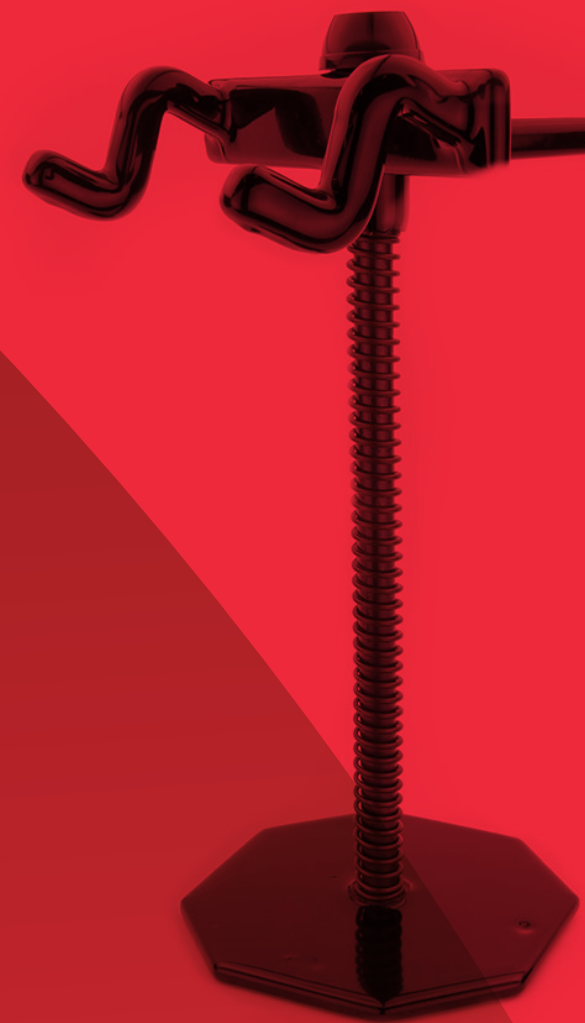

»» Laser System

Tru-Line Truck & Trailer Wheel Alignment System

SKU: TLT-12

MT-RSR Insights:

- TLT-12 Heavy Truck and Trailer Consists of :
- Front Toe Laser Guns
- Rear Targeting
- King Pin Targeting
- Calibration Laser
- Calibration Bar
- Caster Camber Gauge
- Digital Level for Caster on Solid Steer Axles
- Level Compensator, used in non level surfaces
- 2 Wheel/Rim Clamps 17-25"
- Steering Wheel Holder
- Brake Pedal Depressor
- Training Video and Manual
- 2 Year Warranty



Tru-Line Passenger Car and Light Truck system including Accessories

SKU: TL-12 Deluxe

What can the TL-12 Deluxe Laser Wheel Alignment System do?

- Accurate, simple, reliable durable for decades
- No rack required
- Calibrates in the field in seconds
- Surface does not have to be non-level
- Caster, camber, live caster, SAI / KPI
- Toe individual and total toe
- 2 wheel centerline, Thrust angle, and full 4 wheel
- Accurate to 1/64ths inch
- 20 minutes to read entire vehicle
- 100% US made
- Two-year warranty
- Training video and instruction manual
- Runs on D cell batteries
- No cables, computers, or maintenance contracts



Tru-Line Passenger Car Wheel Alignment System (Turntables needed for Pas. Cars)

SKU: TL-12

TL-12 Consists of:

- Front Toe Laser Guns
- Rear Toe Combination Gauges
- Caster/Camber gauge
- Calibration Bar
- 4 Wheel clamps for rims up to 19.5
- Steering Wheel Holder
- Brake Pedal Depressor
- Shipping Weight: 140 lbs.

»» Wheel Clamps

Note: Turntables are required for anything with independent suspensions. Grease Plates or some form of a slip plate is required for smooth adjustments.



Wheel Clamp Extension Plate

SKU: WC550-8

Wheel Clamp Extension Plate (Adds 6" to Current Wheel Clamps).

Includes:

- 8 WC551 (Not sold individually)
- 16 WC559 - Hunter Foot Steel
- 16 WC552 - Hunter Male Adapter



Wheel Clamp Passenger Style Adjustable from 12" to 19" diameter

SKU: 8169

Wheel Clamp Passenger Style Adjustable from 12" to 19" diameter

MT-RSR Insights:

Pairs well with our brake pedal depressor and steering wheel holder. Proudly made in America.



Wheel Clamp Truck Style Adjustable from 16" to 26" diameter

SKU: 8170

Wheel Clamp Truck Style Adjustable from 16" to 26" diameter

MT-RSR Insights:

Pairs well with our brake pedal depressor and steering wheel holder. Proudly made in America.



Wheel Clamp Extension Plate (Set of 4)

SKU: WC550-4

FMC 3 Legs Extender Set for 4 Clamps

Includes:

- 4 WC551 (Not sold individually)
- 8 WC559 - Hunter Foot Steel
- 8 WC552 - Hunter Male Adapter



Brake Pedal Depressor

SKU: 9280

MT-RSR Insights:

This tool is used to depress the brake pedal while you are performing wheel alignments. This tool is quick and easy to adjust. This high-quality, steel construction is proudly made in America. Coated in zinc to prevent rusting. Pair with the 9380 Steering Wheel Holder.



Steering Wheel Holder

SKU: 9380

MT-RSR Insights:

This unit securely centers the steering wheel while the covered hooks and base prevent damage to the steering wheel or seat cover. This tool is very helpful during wheel alignments. 12.5" tall from base to top center. Pair with the 9280 Brake Pedal Depressor.



MADE IN THE U.S.A.



Adapter Foot

SKU: WC562



Extended Foot Adapter

SKU: WC562EXT

Interchangeable Part Numbers:
Hunter OEM #WC562EXT



Hunter Foot Steel

SKU: WC559

Interchangeable Part Numbers:
Hunter OEM # 20-559-1



FMC John Bean Wheel Alignment
OLD Version Rim Claw Long
88797000

SKU: 88797

Interchangeable Part Numbers:
88797000



FMC John Bean Wheel Alignment
System Wheel Clamp Rim Claw
Short 88794000

SKU: 88794

Interchangeable Part Numbers:
88794000

» Spare Parts



1/2" Celcon Repair Part (Pack of 54)

SKU: 9705



5/8" Diameter Celcon Ball for Turn Tables
(Pack of 54)

SKU: 21894



9/16" Delrin Bearings (Pack of 54)

SKU: 13065



Hunter Alignment wheel clamp rim guard
sleeve (Set of 8)

SKU: 20-15221

Interchangeable Part Numbers:
Hunter 20-15221-1



Hunter Male Adapter

SKU: WC552

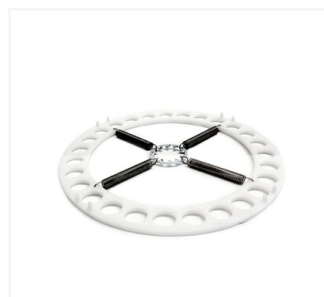

Retainer for 13065 Delrin - ID-6.75" OD
- 7.75"

SKU: 41-43



Rim Guard Sleeve

SKU: WC522

Interchangeable Part Numbers:
Hunter OEM # 20-1522-1

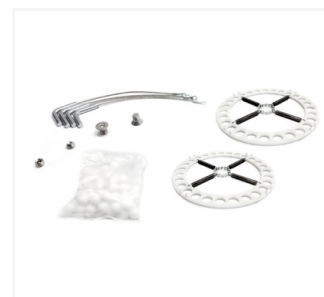

Standard Turn Plate Repair Kit

SKU: 41-11



MT-RSR Insights:

What are Camber Bolts?

Camber adjustment bolts are eccentric bolts that allow you to change the vehicle's camber angle. Camber bolts can be used to adjust the amount of camber (vertical alignment) of a wheel. These bolts can be used to compensate for mis-alignment due to damage to suspension components or to intentionally create camber for an ascetic or performance effect. Camber bolts are a simple but very effective way to eliminate excessive leaning on lowered vehicles. The benefits include longer tire life and better handling.



Camber Bolts, 12.9 level, grey color,
12mm

SKU: 9400-12

Interchangeable Part Numbers:
81260



Camber Bolts, 12.9 level, grey color,
14mm

SKU: 9400-14

Interchangeable Part Numbers:
81250



Camber Bolts, 12.9 level, grey color,
15mm

SKU: 9400-15

Interchangeable Part Numbers:
81270



Camber Bolts, 12.9 level, grey
color, 16mm

SKU: 9400-16

Interchangeable Part Numbers:
81280



Camber Bolts, 12.9 level, grey color,
17mm

SKU: 9400-17

Interchangeable Part Numbers:
81290

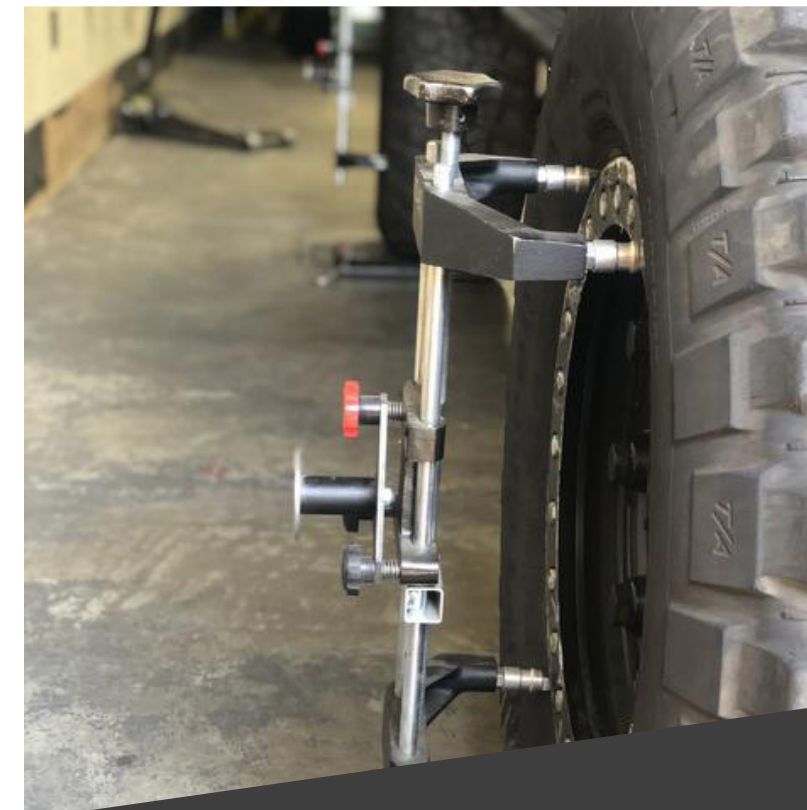

Wheel Alignment

Proper wheel alignment ensures optimal drivability by keeping your tires lasting longer, resulting in a smoother drive. Keeping trucks and trailers in alignment prolongs tire life, which equals money - bottom line!

Shop our TLT-12, TLT-12 Deluxe, and TL-12 systems that are portable, fast, and easy to use. Align your car and light trucks anywhere with our convenient systems with included accessories. We are proud to sell 100% USA Made Tru-Alignment systems

At MT-RSR, our expertise is under-car equipment parts. We proudly service auto and tire shops across the United States. We machine, in-house, and source only the best parts because they represent us. Starting with our incredible employees to our high-quality materials and our high-tech machines, we strive to deliver quality products.

03

TIRE CHANGERS

OEM and aftermarket spare parts for a wide range of tire changer machines. Mount/Demount heads are available in both nylon and metal as well as their inserts and brackets are just the beginning. Whether you need a new valve, your switch has gone bad, or you need new tire patches, we have a wide selection ready to ship same day. Compatible brands include: Coats, Accuturn, Corghi, Hofmann, FMC, and more.





“ **Your #1 equipment parts experts** ”

Mount/Demount Head SALE

Purchasing USA MADE Products Just got easier!



01. Top-Notch Support

Our team delivers expert support & provides clients with multiple video tutorials and Shop Talk Blogs.

02. Next Day Shipping

Shop our 1000+ SKU's that are in stock and all available for next-day shipping.

03. Satisfied Or Refunded

We believe in customer satisfaction; if a client is not satisfied with their product, we offer full refunds.



Coats Nylon M/D Head NO Hardware USA MADE

SKU: 18307USA

Fits the following brake lathe brands: Coats - 5030, 5040, 5050, 5060, 5065, 6050, 6060, 6065, 7050, 7055, 7060, 7065, 7660, 7665, RC55

Interchangeable Part Numbers:

Coats OEM# 182960

MT-RSR Insights:

This durable but flexible nylon material helps to prevent the duck head from scratching rims while changing tires. Also available with hardware as 18306USA. Available as a steel head as 1827888.



Coats Nylon M/D Head with Hardware USA MADE

SKU: 18306USA

Fits the following brake lathe brands: Fits Coats models that have a tapered stud (the part that the shoe mounts on) on the bottom of the shaft. Includes mounting bolt and washers. Not for early models that have a straight stud. Fit's the same model as 18307USA.

Interchangeable Part Numbers:

Coats - 8183061, 182960, 8182960, 183061

MT-RSR Insights:

This durable but flexible nylon material helps to prevent the duck head from scratching rims while changing tires. Also available without hardware as 18307. Available as a steel head as 1827888.

»» Nylon Heads



Corghi, Hofmann, Hunter, Coats Nylon M/D Duck Head Premium

SKU: 45031P

Interchangeable Part Numbers:

All Tool OEM# G3008403, Coats OEM# 83008403, Corghi OEM# 450310, Hofmann OEM# 8314813, Hunter OEM# RP11-8314813, Sice OEM# 8314813



Accu-Turn, FMC and Ranger Nylon Premium Yellow M/D Head

SKU: 20024P

Interchangeable Part Numbers:

Accuturn OEM# 20024335
Hofmann OEM #24335
John Bean and Snap-On OEM# 24335



Accu-Turn, FMC and John Bean Premium Nylon M/D Head Kit

SKU: 140247P

Interchangeable Part Numbers:

Accuturn and Hofmann OEM# 14024784
John Bean and Snap-On OEM# EAA0247G20A



Corghi Yellow Nylon Premium M/D Head

SKU: 25030P

Interchangeable Part Numbers:

All Tool OEM# G3008403, Coats OEM# 83008403, Corghi OEM# 205309, Hofmann OEM#220981, Sice OEM# 220981



Hunter Tire Changer Wing Plastic Mount Head Made in the USA

SKU: 40327U

Interchangeable Part Numbers:

8-1140327, RP11-8-1140328, 8-1140328



Hunter and Accuturn Nylon M/D Head

SKU: 03431

Interchangeable Part Numbers:

Hunter RP6-0343B - Accuturn SM102529 - Bosch SM102529 - Ranger 5150523



Coats Low Profile Grey M/D Head

SKU: 84432

Interchangeable Part Numbers:

Coats 8183061 Nylon Duckhead Mount / Demount Head



Corghi, Hofmann, Hunter, Coats Nylon M/D Duck Head

SKU: 45031

Interchangeable Part Numbers:

All Tool OEM# G3008403, Coats OEM# 83008403, Corghi OEM# 450310, Hofmann OEM# 8314813, Hunter OEM# RP11-8314813, Sice OEM# 8314813



Accu-Turn, FMC and Ranger Nylon M/D Head

SKU: 20024

Interchangeable Part Numbers:

Accuturn # 20024335
Hofmann #24335
John Bean and Snap-On 24335



Accu-Turn, FMC and John Bean Nylon M/D Duck Head Kit

SKU: 140247

Interchangeable Part Numbers:

Accuturn and Hofmann OEM# 14024784
John Bean and Snap-On OEM# EAA0247G20A



Corghi Nylon M/D Head Kit with Round Hole (Black) and Mounting Bracket

SKU: 25030

Interchangeable Part Numbers:

All Tool OEM# G3008403, Coats OEM# 83008403, Corghi OEM# 205309, Hofmann OEM#220981, Sice OEM# 220981



Hunter Tire Changer Wing Plastic Mount Head

SKU: 40327

Interchangeable Part Numbers:

Interchangeable part # 8-1140327, RP11-8-1140328, 8-1140328



Hunter Nylon Red M/D Duck Head

SKU: 03431R

Interchangeable Part Numbers:

Hunter OEM# 221-675-2



Hunter Nylon M/D Head

SKU: 14120

Interchangeable Part Numbers:

Hunter - RP6-710014120



Hunter Bead Roller A34/28

SKU: H-90010

Interchangeable Part Numbers:
RP6-710090010



Hunter Rim-sled Protector

SKU: H-12916

Interchangeable Part Numbers:
Hunter - RP6-12916 RP6-1000A91



Coats Washer Set for Nylon M/D Head

SKU: 18279



Bracket and Screw, used with M/D Head

SKU: TC20025000



Mounting Bracket Used with M/D Head

SKU: TC250

»» Metal Heads



Coats Metal M/D Head with Taper Hole

SKU: 1827888

Interchangeable Part Numbers:
TC182788, TC 182788, 182788, 8182788, 8182753, 81827881, 8183781, 182026, 8182026, 8182753
Coats # 8182788, 8182753, 182788, 182753



Coats Metal M/D Head With Round Hole

SKU: 1834299

Interchangeable Part Numbers:
Ref 322003, 2202073, 8183429, 8182026, 2201432, 8183152, 900258458, 258458, 183429, 182026, 183152



JB/Hofmann/Accturn/FMC Stainless Steel M/D Head

SKU: 26251

Interchangeable Part Numbers:
Snap On: ST4026251, FMC: 87083, John Bean: 0011065, 11065, Hofmann: EAA0329G95A



Corghi/Hunter/Cemb/Coats/Early Hoffman M/D Head (Set Screw on Side)

SKU: 184387

MT-RSR Insights:
Can be used with MT-RSR protector # 26253 & 24716.

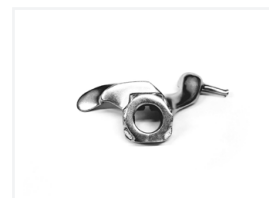

Corghi/Hunter/Cemb/Coats/EarlyHoffman M/D Head (Set Screw in Front)

SKU: 184388

MT-RSR Insights:
Can be used with MT-RSR protector # 26253 & 24716.

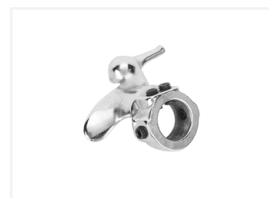

Corghi/Hunter/Cemb/Coats/EarlyHoffman Stainless Steel M/D Head for Motorcycles

SKU: 184037

MT-RSR Insights:
Can be used with MT-RSR protector # 24716



Hoffmann Spacer for adapting M/D Head

SKU: 183429SP



Sicam/Bosch/M&B Stainless Steel M/D Head

SKU: 26252

MT-RSR Insights:
29mm Bore



Repair Roller for M/D Head

SKU: 182429R



Roll Pin For TC2001 1064 M/D Head Insert - Tire Repair

SKU: 76079

»» Inserts for Heads



#	MT-RSR Part Number	Description	Interchangeable Part Numbers:
1	19306	Coats Front/hook inserts for lever-less Tire Changer - 5PK	89233409, 9233409, 84393753, 83033278
2	19305	Coats Tail insert for lever-less Tire Changer - 5PK	89233409, 9233409, 84393753, 83033278
3	113G61AY	Slotted Yellow 10PK Inserts for Hofmann, John Bean and Snap-On	ST0011064, ST4024181, EAC0078G50A, EAA0247G15A
4	47G15A-10	Black Long Protector for M/D Head (10 Pack)	TC247G15A-10, EAA0247G15A, ST0011064
5	28119	Ranger Tire Changer Back/Tail Inserts 10PCS	5328119
6	27636C	Ranger Tire Changer Front/Nose Inserts 10PCS	5327636
7	H-10326	Leverless Mount Head Inserts Right Side V3	Corghi For V3 Leverless Tool Head, Hunter RP11-8-1110326S, Sice Models S 45TL, S48 TL, S 48PL, S100 PL
8	2685	Triangle Insert for leverless Hunter/Corghi (10 Pack)	Fits the following tire changer brands: Hunter : V1-V2-V3 20-2685-3 and others. Corghi- 4-106611A
9	2684	Rectangular Inserts for Leverless Head Hunter/Corghi - 10 Pack	Replacement for Hunter Part # 20-2684-3, RP11-8-11400293
10	TCY2064-10	Short Yellow Mount/Demount Head Protector (10 Pack)	Accuturn - 20011064, 24016079
11	20011064	Mount/Demount Bill Insert (Pack of 10)	
12	1489-1167	Mounting Inserts for Corghi Master 2002-UP 10 Pack (5 of each insert)	461489A, 900461489, 461489
13	25434	Yellow Corghi/Coats Metal Head Inserts - 10 Pack	8-11100106 , 254341A
14	24716	Yellow Nylon Insert For Coats/Corghi Round Hole and others	8-11100106, 254341A, 063905900
15	24715	Yellow Long Protector for M/D Head (10 Pack)	OEM / Aftermarket Interchanges: TC247G15A-10, EAA-0247G15A, ST0011064
16	101608	Protectors (5 Pack)	TC101608, 100798 (single insert), 101608, 1695101608810, 1695101608 (set of 5 inserts).
17	26253	Tail Inserts for Many Make and Model Tire Changers	8-11100107,801258898, 063906300, 20010236
18	H-221713	Hunter Style Polymer Mount Head (5 Pack)	221-713-2
19	102725	Bosch, Sicam Accuturn Black Rear Mount Demount Protector	OEM #102725 Accuturn, ADG, Bosch, OEM # 169510725 Sicam



Hunter Wheel Protector Kit Head/Tail (Pack of 10)

SKU: 11400096

Interchangeable Part Numbers:
RP11-8-11400096,
RP11-8111003035



Coats SS M/D Head Insert (Pack of 12)

SKU: TI182963

Interchangeable Part Numbers:
TI182963, TI 182963, 8182961,
8182963, 182961, 182963

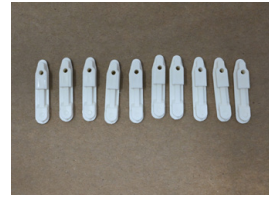

Insert for Hunter 500 Series (Pack of 10)

SKU: TI14636

Interchangeable Part Numbers:
RP11-8-11400096,
RP11-8111003035



Front Insert for Hunter 500 Series (Pack of 10)

SKU: TI14096

Interchangeable Part Numbers:
RP11-8-11400096,
RP11-8111003035



Hunter Insert TCX SQ PK20..Hunter and CEMB

SKU: 400369

Interchangeable Part Numbers:
RP11-8-11100369

>>> Valves & Spools



81881 Control Valve Bead Loosener (Spring Center)
Interchangeable Part Number: Coats # 8185581



AAA-81881 AAA Control Valve Bead Loosener (Spring Center)
Interchangeable Part Number: Coats # 8185581



184369 4 Way Air Valve With Internal Centering Spring
Interchangeable Part Number: Other# TC184369, Coats # 8181986



81995 Coats 4-Way Piloted/Slave Valve Housing
Interchangeable Part Number: 8181995, 181995



81895 4 Way Piloted / Slave Valve Housing for Coat



81986 4 Way Valve Housing for Coats
Interchangeable Part Number: 8181986, 181986



SPOOL986 Spool for the 81986
Interchangeable Part Number: 8181986X



SPOOL369 Spool for the 184369
Interchangeable Part Number: 1814369X



TC9596 Tire Changer O-Ring Replacement Kit (Pack of 6)
Interchangeable Part Number: TC9596, TC 9596, TC-9596

>>> Cylinders & Seal Kits



Pivot Pin for Bead Loosener Rod (New Style)

SKU: 67837

Interchangeable Part Numbers:
8185634, 185634, 85607837



Pivot Pin for Bead Loosener Rod (old style Round Foot Operated)

SKU: 182550

Interchangeable Part Numbers:
8182550



Replacement Cylinder Sleeve/ Barrel for Bead Breaker Coats 50 & 70 Series

SKU: 81574

Interchangeable Part Numbers:
8181574



Replacement Cylinder Sleeve/ Barrel for Table Top Coats 50 & 70 Series

SKU: 81627

Interchangeable Part Numbers:
8181627, 181627



Coats Cylinder End Cap for Table Top - Bottom

SKU: 81622

Interchangeable Part Numbers:
181622



Front Cap or Top Cap Table Top Cylinder

SKU: 81620

Interchangeable Part Numbers:
1818620, 181620



Bead Breaking Cylinder Seal Kit

SKU: 18207

Interchangeable Part Numbers:
182079 & 8182079



Coats Tire Changers Table Top Cylinder

SKU: 81162

Interchangeable Part Numbers:
181162, 8181162



Coats Table Top Tire Changer Small O-Ring

SKU: 81712

Interchangeable Part Numbers:
181712, 8181712

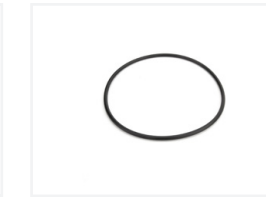

Coats Large O-Ring for Table Top Tire Changer

SKU: 81713

Interchangeable Part Numbers:
181713, 8181713

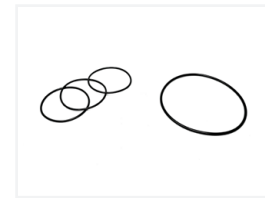

O Ring Repair set for Coats Table Top Tire Changer

SKU: 81715

Includes: 81712 & 81713



Table Top Cylinder Seal Kit for Coats 5030, 5060 or 5070

SKU: 83811

Interchangeable Part Numbers:
TI183811, TI 183811, 183811,
8183811, 8183772, 8182080



Coats Rim Clamp Replacement Shaft - Bead Loosener

SKU: 183519

Interchangeable Part Numbers:
8181629, 181629



Replacement Table Top Cylinder Shaft

SKU: 181629

Interchangeable Part Numbers:
8181629, 181629



Turn Table Repair Kit, Corghi

SKU: 238548

Interchangeable Part Numbers:
Corghi 238548, 900238548



7" Bead Loosener Cylinder Seal Kit for Coats

SKU: 12638

Interchangeable Part Numbers:
182638, 8182638

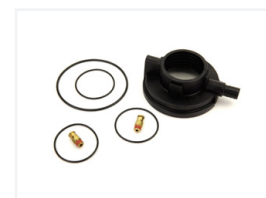

Coats Rotary Coupling Assembly

SKU: TC182034

Interchangeable Part Numbers:
Coats- 8182619



Coats Bead Breaker Kit

SKU: TI115

Interchangeable Part Numbers:
Coats OEM: 8181163, 8181642
Corghi OEM: 223810, 238212

»» Switches & Gauges



Coats and Corgi Tire Changer Forward Reverse Switch 40Amp

SKU: 21523

Interchangeable Part Numbers:
424796, 900424796, 435363,
900435363, 421523, 900421523



Motor Forward Reverse Switch for Tire Changer

SKU: 400682

Interchangeable Part Numbers:
8182958, Coats OEM #8182958,
182958, REPLACES HOFMANN #
4213369 5-400682, Replaces Part
#182958



Old Accutum and Some snap-on Tire Changer Reversing on/off Single Phase Switch

SKU: 86433

Interchangeable Part Numbers:
Snap-on - ST0016433



Tire Changer Forward Reverse Switch 20 AMP

SKU: 184390



Corgi and Coats Tire Changer Forward Reverse Switch 40 Amp

SKU: 82958

Interchangeable Part Numbers:
8182958, Coats OEM #8182958,
182958, REPLACES HOFMANN #
4213369 5-400682, Replaces Part
#182958



Switch for Coats 5000, 6000 and 7000 series Tire Changers (Premium version)

SKU: 84389

Interchangeable Part Numbers:
SW184389, SW-184389,
8182957, 8182958 184389,
8184389, BW-1243-89,
85607129, 85607250, 81827336



FMC Air Gauge for Tire Changers

SKU: AG66170

Interchangeable Part Numbers:
FMC/John Bean: 66170, Model
#: 7600, 8800, Hofmann: 66170,
Model #: All Models, Snap-On:
66170



Coats Air Gauge for Tire Changers

SKU: AG107985

Interchangeable Part Numbers:
AG107985, 107985, 8107985



Coats Air Gauge for Tire Changers

SKU: 107985

Interchangeable Part Numbers:
AG107985, 107985, 8107985



Old Style Coats Air Gauge for Tire Changers (AG107918)

SKU: AG107918

Interchangeable Part Numbers:
Coats - AG107518, AG 107518,
107518, 8107518

»» Mounting Compound Accessories



Tire Swab for Lube Bucket

SKU: TI00050

Interchangeable Part Numbers:
TI35, TI 35, 000491, 8000491,
4215799, 8000491,
BL8000491



Replacement Brush/Lid For Cement Can

SKU: X14381B



Angled Applicator Brush

SKU: TI1506

Interchangeable Part Numbers:
30512, 96517



Lube bucket Bracket

SKU: 7559

Comes with two 36" cable ties for mounting



Bracket for Universal Mounting Paste

SKU: Bracket75NB

Use with X14700



Straight Top Lube Bucket (Red)

SKU: 7259

Interchangeable Part Numbers:
LB106259, LB 106259, 8106259, 106259



Angled Top Lube Bucket (Red)

SKU: 7572

Interchangeable Part Numbers:
LB106572, LB 106572, 8106572



Euro-Paste Mounting Compound with Rust Inhibitors 6.5 lb bucket

SKU: X14700

Use with Bracket75NB



25 lb. MURPHY'S Mounting Compound

SKU: X14725

»» Manual Machine Replacement Parts



Coats 8108276 Hold Down Cone

SKU: 0433

Interchangeable Part Numbers:
MT-RSR # 108276, COATS #
8108276 000433 & 800433,
Hofmann Montly # 66667, FMC
66667



Coats Hold Down Cone

SKU: 108276

Interchangeable Part Numbers:
MT-RSR # 108276, COATS #
8108276 000433 & 800433,
Hofmann Montly # 66667, FMC
66667



Coats Combo Tool

SKU: 768

Interchangeable Part Numbers:
Coats: 8000768, John Bean /
FMC / Hofmann: 66679, Hunter:
RP6-1828



Hoffmann and FMC Combo Tool

SKU: 66679



Special Combo Tool

SKU: 85609418



Motorcycle Combo Tool Wheel Protection

SKU: 7423



White Demount Bootie

SKU: TI00030



White Mount Bootie

SKU: TI00055



Coats Mount Demount Bootie Kit for Combo tool Coats # 8000768

SKU: 107790



»» Inflator Hoses - Spare Parts



60" Inflator Hose Assembly (Open Coupling one side, 1/8" Male BSP on other side)

SKU: TI00012

Interchangeable Part Numbers:
Corgi 714100, Hoffmann 2407055



54" Inflator Hose Assembly (Open Coupling one side, blank on other side)

SKU: TI00013



11" Inflator Hose Assembly (Open Coupling one side, blank on other side)

SKU: TI00014



60" Inflator Hose Assembly (Open Coupling one side, 1/4-18" Male NPT on other side)

SKU: TI00015

Interchangeable Part Numbers:
Coats # 106871



60" Inflator Hose Assembly (Open Coupling one side, 1/8-28 Male BSP on other side)

SKU: TI00017

Interchangeable Part Numbers:
Hofmann # 2408318



54" Inflator Hose Assembly With Spring Guard (Open Coupling one side, 1/4" Female NPT Swivel on other side)

SKU: TI00020

Interchangeable Part Numbers:
FMC / John Bean # 67715



60" Inflator Hose Assembly (1/4" Male NPT Both sides)

SKU: TI00025

Interchangeable Part Numbers:
OEM / Aftermarket: HA106871, HA 106871, 106871, 8106871, 2009045, 8105822, 8410419, 137-86-2, 2408318, 4205451



62" Inflator Hose Assembly (Open Coupling one side, blank on other side)

SKU: TI00026



Flexzilla Air Hose, 1/2" X 100', 3/8"

SKU: 12100YW3



Flexible Braided Metal Rubber Valve Extension - 14"

SKU: HAM-116581



Flexible Braided Metal Rubber Valve Extension - 8.25" (210mm)

SKU: HAM-116571

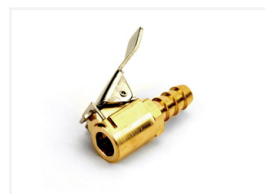

Euro Coupling for Inflator Hose

SKU: 202

Interchangeable Part Numbers:
Coats #: 8410419, Hunter #: 145-341-2, Snap-on #: ST006993



Air Chuck-Open End

SKU: 203



1/4" Female Air Chuck-Closed End

SKU: 204

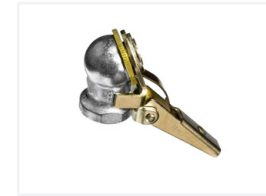

Milton 698 1/4" FNPT Single Head Air Chuck with Grip

SKU: MIL-698

Interchangeable Part Numbers:
Corgi 714100 Hoffmann 2407055



Milton 699 1/4" Single Head Air Chuck

SKU: MIL-699



Milton 715 1/4" FNPT M Style Coupler

SKU: MIL-715



Milton (716) 1/4" Male NPT M Style Coupler

SKU: MIL-716

Interchangeable Part Numbers:
Coats # 106871



Milton 727 1/4" MNPT M Style Plug

SKU: MIL-727

Interchangeable Part Numbers:
Hofmann # 2408318

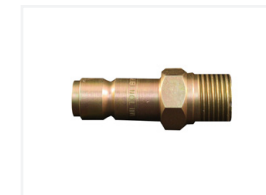

Milton 1817 1/2" MNPT G Style Plug

SKU: MIL-1817

Interchangeable Part Numbers:
FMC / John Bean # 67715



Milton 1818 1/2" FNPT G Style Plug

SKU: MIL-1818

Interchangeable Part Numbers:
OEM / Aftermarket: HA106871, HA 106871, 106871, 8106871, 2009045, 8105822, 8410419, 137-86-2, 2408318, 4205451



Re-Cappers F. Plug M-Style

SKU: MIL-731



Digital Air Dual Chuck Tire Inflator

SKU: 89001



Milton S-506 Dual Head Chuck Inflator Gauge with 15 Inch Hose

SKU: MIL-S506



Xtra Seal Deluxe Tire Buffer w/ Quick Change & Exhaust Hose Kit

SKU: X14319DX

Interchangeable Part Numbers:
167-12461



Milton EX0500D Exelair Digital Pistol Grip Tire Inflator/Deflator Gauge

SKU: MIL-EX0500D

»» Tire Repair

Xtra Seal 32 oz. (945ml) Bead Sealer	Xtra Seal 32 oz. (945ml) Buffing Solution	Xtra Seal 8 oz. (236ml) Vulcanizing Cement, Flammable	Xtra Seal 16 oz. (472ml) Inner Liner Sealer, Flammable	Lead Wire Insert for 1/4" (6mm) Injury (Box of 20)
SKU: X14101	SKU: X14100	SKU: X14008	SKU: X14128A	SKU: X13620
Xtra Seal 1 5/8" (41mm) Small Round (Box of 30)	Xtra Seal 2 1/4" (57mm) Medium Round (Box of 25)	Xtra Seal 2 1/4" (57mm) Medium Round Feather-Edge (Box of 30)	Xtra Seal 2 1/4" (57mm) Medium Square Euro-Style (Box of 50)	Xtra Seal Patch 2 1/8", for 3/8" Injury (Box of 16)
SKU: X11321	SKU: X11322	SKU: X11002	SKU: X11311	SKU: X13675
Xtra Seal Patch: 1 5/8" (42mm), Stem: 3/16" (5mm) (Box of 24)	Xtra Seal Patch: 2 1/8" (55mm), Stem: 1/4" (7.5mm) (Box of 24)	Xtra Seal Lead Wire Insert for 3/16" (4.5mm) Injury (Box of 20)	Xtra Seal Lead Wire Insert for 3/8" Injury	Xtra Seal 2 1/4" x 4" (57 x 102) Radial 12, 1 Ply (Box of 10)
SKU: X13672	SKU: X13673	SKU: X13621	SKU: X13623	SKU: X11712
Xtra Seal White Paint Stick, 1/2" Hex (Pack of 12)	Xtra Seal White MARKALL Paint Stick, 3/4" Round (Pack of 12)	Xtra Seal 2 1/2" Light Duty Carbide Buffing Wheel, BC-1	Xtra Seal 2" Dome Economy Buffing Wheel, 60 grit	Xtra Seal In-Line Air Regulator, 1/4" npt
SKU: X14553	SKU: X14554	SKU: X14320	SKU: X14359	SKU: X14318R
Xtra Seal Nitrile Coated Red Mechanics Glove (Each)	Xtra Seal Safety Glasses (Each)	Xtra Seal 15" (381mm) Cotton Tire Swab	Xtra Seal Tire Repair Cabinet with H.D. Product Assortment	Xtra Seal Tire Service Set with Wall Cabinet
SKU: X14803	SKU: X14802	SKU: X14378L	SKU: X14605	SKU: X14603

Tire Spreader, adjustable from 0-10"	Base for Tire Spreader 7828	LED Work Light Assembly w/ Mounting Bracket 650 Lumens	Xtra Seal 1/2" Reversible Air Drill, 800 rpm & Exhaust Hose Kit	Kit DP-090-B (5) & DP-T090-B
SKU: 7828	SKU: 7329	SKU: WL-8473	SKU: X14326K	SKU: DP-090-K
4" Brown Tire String 60 individual Strings per Box - 36 Master case	7.75 Brown Tire String 30 individual Strings per Box	Orange Bowtie, 2 1/4" x 3/8", 5-PLY 50/box	Tire Repair Kit - Black	Tire Repair Kit - Red
SKU: TR-1004	SKU: TR-1075	SKU: X12-331	SKU: TRK-Blk	SKU: TRK-Red

»» Lug Nuts



#	MT-RSR Part Number	Description	Interchangeable Part Number:
1	94011	Bulge Acorn 14MMX1.50 13/16 HEX-008-B	
2	94012	Bulge Acorn 14MMX2.00 13/16 HEX-288	BD142978; 4L3Z-1012-A; 7L1Z1012A, 611-288
3	WN-76-B	Lug Nut M12-1.25 Acorn	
4	WN-196-B	Flange Nut M14-2.0 Black	
5	WN-236	Lug Nut M14-1.5 Flattop-22mm Hex, 44.5MM - 1709DL	
6	WN-236-B	Flattop Nut M14X1.5 - 22 Hex	
7	WN-246-B	Wheel Nut M14-1.5	2C2Z1012AA, BD142983, 611-246
8	WN-288-B	Domtop Nut M14-2.0 - 21 Hex	BD142978; 4L3Z-1012-A; 7L1Z1012A, 611-288
9	WN-303-B	Cap Nut M12-1.5 Chrome	
10	WN-330-B	Cap Nut M14-1.5 Chrome	

Tire Changers Misc.

At MT-RSR our goal is to have everything you need in stock and ready to ship same or next day. Whenever you need tire changer supplies, think MT-RSR. Whether it's as small as a torsion spring or as big as an electric motor, we keep it in stock and available for your convenience.



#	MT-RSR Part Number	Description	Interchangeable Part Numbers:
1	18135	Bead Lifting Tool (20")	TC181354, TC 181354, 430679, 8181354, 0001418, 3009516, 87111
2	18135-24	Bead Lifting Tool (24")	TC181354, TC 181354, 430679, 8181354, 0001418, 3009516, 87111
3	TC2505	Wave Style Bead Lift Tool Bar	
4	1126	Bolt Remover	
5	708260	Coats Drive Gear Bearing Assembly	
6	181696	Coats Cam Follower Lever	TC181696, 181696, 8181696, 8-181696, BW-1216-96, 8501003
7	81685HD	Heavy Duty Drop Center Tool	Replaces Corghi Part # 262417A, Alternate Part # TC435685 TC-435685 TC 485685, 262417
8	81685	Drop Center Tool	2200011, RP6-70210E, 435685, 4003444, 4356851, 84356851, 8435685, 1400344, 435685A, 6410190, 5800084-13, EAA0247G70A
9	11400098	Long Sock for 18135 (Pack of 4)	
10	89195	Filter Lubricator/Regulator 7-145 PSI 40 Micron 1/4" NPT, 18 CFM	
11	2216592	Bead Starting Tool 221-659-2 For Tire Changers	2216592, 4-405496
12	18110	Coats Electric Motor	8184691, 184691, 8181100, 181100, 81846911, 1846911
13	LP181035	Coats Lift Pin Lock Plate	8181035, 181035
14	81707	Coats Torsion Spring For The Motor Return Pedal	BW-1217-07, 8181707, 181707, SP8181707, SP181707, 8-181707
15	10-9953	Bead Seater 5 Gallon	
16	84691	Wire Harness for Coats Electric Motor	
17	18231	Miniature 3 Way Control Valve	182317, 8182317, 8-182317, 8182725, 182725
18	85185	Bead Breaker Rubber Pad Kit 1 LG-81855 And 2 SM-81851	
19	81855	Large BB Center Rubber Pad	8181855, 181855, TI181855
20	81851	Coats BL Small Nylon Pad	8181851, 181851, TI181851, TI-181851
21	81065	Coats Bead Breaker Rubber Pad for RC15 and RC20	
22	181695	Coats Cam Mounting Block	TC181695, 181695, 8181695
23	TC183605	Quilted Sock Short (Pack of 10)	TC183605, TC 183605, 183605, 8183605
24	800A11	Hunter TC & A-28 Series Shovel Protector	RP6-G800A11
25	5-490223	Hunter TCX Series Shovel Protector	RP11-5-490223, TAXP-BBSRP, 20100180
26	83606	Protector Shovel Cover for Bead Breaker Shovel on COATS	83606 & 8183606
27	TC0066-4	Tulip Style Gripping Pads (Pk. Of 4)	Hunter Part # RPO066, RP6-40032, Hunter RP6-0066

JAWS

Shop our collection of jaws ranging from rim clamp jaws to extension clamp jaws. At MT-RSR, we believe spare parts are a tire shop's best friend. Corghi Jaw Protectors, Sicam Jaw Covers, and Quilted Clamp Socks are spare parts that save money and time.

The rigid plastic material on the covers protects the wheels from scraping and gouging. It acts as a barrier between the metal jaws on the machine and the wheels; flexible enough to prevent damage but tough enough to remove tires.



#	MT-RSR Part Number	Description	Interchangeable Part Numbers:
1	18412-4	Coats Adjustable 3 Button Rim Clamp Jaw (Range: 6" - 22") Set of 4 Coats	Coats # 8187926 & 8184126
2	18412-4B	Set Of 4 Adjustable 3 Button Rim Clamp Jaw (Range: 6"-22") with 4 Buttons.	Coats # 8187926 & 8184126
3	18495-4	Coats Extension Clamp Jaw (Range 18" - 28") Set of 4	Coats #818948
4	18495-4B	Set of 4 Extension Clamp Jaws (Range: 18"-28") with 4 Buttons.	OEM Coats #818948
5	18426-4	Coats Adjustable 2 Button Rim Clamp Jaw (Range: 13" - 24") Set of 4	OEM Coats #8184327
6	18426-4B	Set of 4 Adjustable 2 Button Rim Clamp Jaws (Range: 13"-24") with 4 Buttons.	OEM Coats #8184327
7	182247-4	Coats Adjustable 2 buttons Rim Clamp Jaw (Range: 6" - 20") (Set of 4)	OEM Coats # 81822474
8	182247-4B	Set of 4 Adjustable 2 Button Rim Clamp Jaw (Range: 6"-20") with 4 Buttons.	OEM Coats # 81822474
9	82250	Coats Button For Clamping Jaws	Coats # 8182250
10	RC1-4	Coats Tire Changer Clamp	TC336742-4, 336742, 323156, 8181677
11	TC183604	Quilted Clamp Socks (Pack of 10)	TC183604, 183604, 183604-10, TC183604, TC183604-10, 8183604, 8435203
12	TCB304	Jaw Protection	
13	24720	Wheel Jaw Covers for Coats Ranger and Others - Set of 4	Replaces COATS Part Number : 82006393, 9209612
14	101402	Sicam Jaw Cover (Pack of 4)	100816, 1695101402, 100816
15	716108	8PK Grip Max Coats Jaw Inserts	85607161, 85607108 - Black Grip Max Inserts
16	100108	Corghi Jaw Protector Inside Pack of 4	8-11100108
17	H-100358BK	Clamp Protectors 4PK Small BLK..A2024TI A2019TI A2010TI MTS 2010 MTS 24, Hunter, Ranger / Atlas / Triumph / Private Label, Universal	
18	H-100358Y	Clamp Protectors 4PK Small Yellow..A2024TI A2019TI A2010TI MTS 2010 MTS 24, Hunter, Ranger / Atlas / Triumph / Private Label, Universal	



04

BRAKE LATHES

Everything a shop needs to repair or improve a brake lathe. Cones, adapter sets, chucks, and more to be able to do more with your brake lathe. Arbors, repair kits, pulleys, belts, boots, and more to get your lathe back up and running in no time. We also carry variety of accessories like silencers and chip shields. As always, a majority of the parts are USA made and every part is high quality.





»» Cones & Adapter Sets



Bronze Adapter Set Bosch , Accuturn , Ammco

SKU: 10006

Interchangeable Part Numbers:
Bosch 169900019635E

Includes:

MT-RSR Part #	Description
7193	5 3/4" Diameter Bell Clamp 1" Bore (2X)
7490	Small Bell Clamp 4 1/2" - 1" Bore (2X)
5030	Double End Adapters 1" Bore - Range: 1.32" - 2.89" (Set of 5)
7903	Cone 1" Bore - Range: 1.187" - 2.250"
5040	Spacer 1" Bore x 1" Length
7110	Spring for Ammco
10073	Centering Cone Range: 2.025" x 3.99" - 1" Bore (2X)
6032	Large Ventilated Disc Rotor Silencer Range: 10-12" Diameter
6039	Small Black Solid Rotor Silencer Band for Use on Thin Rotors 6-9" (2 Pcs. pack)



Gold Adapter Set Ammco, AccuTurn, Bosch, Hunter

SKU: 10008

Includes:

MT-RSR Part #	Description
10072	Rotor Hub Base
10073	Centering Cone Range: 2.025" x 3.99" - 1" Bore
10074	Spacer 2" Length and 1" Bore (2X)
10075	Flange Plate
10079	Centering Cone Range: 1.84" x 2.20" - 1" Bore
10080	Centering Cone Range: 2.12" x 2.48" - 1" Bore
10081	Centering Cone Range: 2.38" x 2.75" - 1" Bore
10082	Centering Cone Range: 2.65" x 3.03" - 1" Bore
10083	Centering Cone Range: 2.93" x 3.30" - 1" Bore
10091	Spring Adaptek Style
9800	Rotator Spring Silencer Assembly
6041A	Clip on Disk Silencer
5030	Double End Adapters 1" Bore - Range: 1.32" - 2.89"
10078	Light Truck Flange Plate
10084	Centering Cone Range: 3.20" x 3.58" - 1" Bore
10085	Centering Cone Range: 3.48" x 3.85" - 1" Bore



Silver Adapter Set Ammco, Accuturn, Hunter, Bosch

SKU: 10007

MT-RSR Insights:
Fits Any 1" Arbor Lathe

Includes:

MT-RSR Part #	Description
10072	Rotor Hub Base
10073	Centering Cone Range: 2.025" x 3.99" - 1" Bore
10074	Spacer 2" Length and 1" Bore (2X)
10075	Flange Plate
10079	Centering Cone Range: 1.84" x 2.20" - 1" Bore
10080	Centering Cone Range: 2.12" x 2.48" - 1" Bore
10081	Centering Cone Range: 2.38" x 2.75" - 1" Bore
10082	Centering Cone Range: 2.65" x 3.03" - 1" Bore
10083	Centering Cone Range: 2.93" x 3.30" - 1" Bore
10091	Spring Adaptek Style
9800	Rotator Spring Silencer Assembly
6041A	Clip on Disk Silencer
5030	Double End Adapters 1" Bore - Range: 1.32" - 2.89"



Complete Adapter Set for Passenger Car and Light Truck (Hubless flat Rotors)

SKU: 10010

Interchangeable Part Numbers:
Adaptek™ adapters # 9311 & 9312, Accuturn # 8011 & 8012

Includes:

MT-RSR Part #	Description
10074	Spacer 2" Length and 1" Bore (2X)
10091	Spring Adaptek Style
10085	Flange Plate
10072	Rotor Hub Base
10073	Centering Cone Range: 2.025" x 3.99" - 1" Bore
10081	Centering Cone Range: 2.38" x 2.75" - 1" Bore
10083	Centering Cone Range: 2.93" x 3.30" - 1" Bore
10079	Centering Cone Range: 1.84" x 2.20" - 1" Bore
10082	Centering Cone Range: 2.65" x 3.03" - 1" Bore
10080	Centering Cone Range: 2.12" x 2.48" - 1" Bore
10078	Light Truck Flange Plate
10084	Centering Cone Range: 3.20" x 3.58" - 1" Bore
10085	Centering Cone Range: 3.48" x 3.85" - 1" Bore



Premium-choice Adapter Set Ammco, Accu-Turn , Bosch

SKU: 10009

Interchangeable Part Numbers:

Ammco # 900003, Bosch # 169900020235E

Includes:

MT-RSR Part #	Description
10010	Complete adaptor set for Passenger Car and Light Truck (Hubless flat Rotors) (Set) - See page 47
10076	Truck Flange Plate
10077	Truck Flange Plate
10086	Centering Cone Range: 3.74 X 4.13" - 1" Bore
10087	Centering Cone Range: 4.03" X 4.40" - 1" Bore
10088	Centering Cone Range: 4.30" X 4.68" - 1" Bore
10089	Centering Cone Range: 4.58" x 4.95" - 1" Bore
10090	Centering Cone Range: 4.85" x 5.23" - 1" Bore
10027	Centering Cone Range: 5.125" x 5.50"
5030	Double ended Adapter 1" Bore Range 1.32" - 2.89" (5 pcs Set)
5038	Double ended Adapter 1" Bore - Range: 2.828 - 3.560 Truck Set ref. 5036 + 5037
9800	Rotor Spring Silencer Assembly (Length: 25")
6041A	Clip on Disc silencer
6037	2 3/4" Truck Drum Silencer Band Extra Long (Length: 6')
6030	Natural Rubber Adjustable Ventilated Rotor Silencer Band-Fits Any Vented Rotor



Complete Adapter Set for Light Truck (Hubless flat Rotors)

SKU: 10012

Interchangeable Part Numbers: Similar to Ammco 9012

Includes:

MT-RSR Part #	Description
10078	Light Truck Flange Plate
10084	Centering Cone Range: 3.20" x 3.58" - 1" Bore
10085	Centering Cone Range: 3.48" x 3.85" - 1" Bore

Complete Adapter Set for Heavy truck (Hubless flat Rotors) Ammco , Hunter, Accuturn, Bosch

SKU: 10013

Interchangeable Part Numbers: Ammco # 9313

Includes:

MT-RSR Part #	Description
10076	Truck Flange Plate 10076
10077	Truck Flange Plate 10077
10086	Centering Cone Range: 3.74" x 4.14" - 1" Bore
10087	Centering Cone Range: 4.03" x 4.40" - 1" Bore
10088	Centering Cone Range: 4.30" x 4.68" - 1" Bore
10090	Centering Cone Range: 4.58" x 4.95" - 1" Bore
10091	Spring Adaptek Style System
10027	Centering Cone Range: 5.125" x 5.50" - 1" Bore

Double ended Adapter 1" Bore Range 1.32" - 2.89" (5 pcs Set)

SKU: 5030

Interchangeable Part Numbers: Ammco # 9232, Accuturn # 433963, 433708, 433709, 433710, 433711

Includes:

MT-RSR Part #	Description
5031	Double End Adapters 1" Bore - Range: 1.332" - 1.670"
5032	Double End Adapters 1" Bore - Range: 1.362" - 1.710"
5033	Double End Adapters 1" Bore - Range: 1.711" - 2.073"
5034	Double End Adapters 1" Bore - Range: 2.074" - 2.440"
5035	Double End Adapters 1" Bore - Range: 2.441" - 2.89"

Double ended Adapter Set - Truck Set

SKU: 5038

Interchangeable Part Numbers: 9233, 909233, 9195, 909195, 9196, 909196

Available In:

Bore Size	1"	1 7/8"
Kit SKU Number	5038	5038-1 7/8
Range: Individual Part Numbers		
Double End Adapters - Range: 2.828" - 3.185"	5036	5036-1 7/8
Double End Adapters - Range: 3.203" - 3.560"	5037	5037-1 7/8



Complete Adapter Set for Passenger car (Hubless flat rotors) Ammco, Hunter, Bosch, Accuturn

SKU: 10011

Interchangeable Part Numbers:

Ammco # 9311

Includes:

MT-RSR Part #	Description
10074	Spacer 2" Length and 1" Bore (2X)
10091	Spring Adaptek Style System
10075	Flange Plate
10072	Rotor Hub Base
10073	Centering Cone Range: 2.025" x 3.99" - 1" Bore
10081	Centering Cone Range: 2.38" x 2.75" - 1" Bore
10083	Centering Cone Range: 2.93" x 3.30" - 1" Bore
10079	Centering Cone Range: 1.84" x 2.20" - 1" Bore
10082	Centering Cone Range: 2.65" x 3.03" - 1" Bore
10080	Centering Cone Range: 2.12" x 2.48" - 1" Bore





22 pcs adapter Set with 1" Bore Ammco

SKU: 7347

Interchangeable Part Numbers:
Ammco - 4000, 4100, 7500, 7700
Includes:



MT-RSR Part #	Description
7106	Cone 1" Bore - Range: 3.421" - 4.031"
7107	Cone 1" Bore - Range: 2.89" - 3.500"
7108	Cone 1" Bore - Range: 2.328" - 2.968"
7178	Cone 1" Bore - Range: 2.606" - 3.224"
7902	Cone 1" Bore - Range: 1.250" - 1.750"
7903	Cone 1" Bore - Range: 1.187" - 2.250"
7904	Cone 1" Bore - Range: 1.703" - 2.750"
5030	Double End Adapters 1" Bore - Range: 1.32" - 2.89"
7110	Spring for Ammco
7125	Spacer 1" Bore and 1/2" Length
7492	Self Aligning Spacer
7193	5 3/4" Diameter Bell Clamp 1" Bore (2X)
7489	Small Bell Clamp 3.62" - 1" Bore
7490	Small Bell Clamp 4 1/2" - 1" Bore (2X)
7101	1" Arbor for Ammco
7102	Arbor Nut for 7101

20 Piece Adaptor Set with 1" Bore AMMCO, Accuturn, Bosch, Hunter

SKU: 7347A

Includes:



MT-RSR Part #	Description
7106	Cone 1" Bore - Range: 3.421" - 4.031"
7107	Cone 1" Bore - Range: 2.89" - 3.500"
7108	Cone 1" Bore - Range: 2.328" - 2.968"
7178	Cone 1" Bore - Range: 2.606" - 3.224"
7902	Cone 1" Bore - Range: 1.250" - 1.750"
7903	Cone 1" Bore - Range: 1.187" - 2.250"
7904	Cone 1" Bore - Range: 1.703" - 2.750"
5030	Double End Adapters 1" Bore - Range: 1.32" - 2.89"
7110	Spring for Ammco
7125	Spacer 1" Bore and 1/2" Length
7492	Self Aligning Spacer
7193	5 3/4" Diameter Bell Clamp 1" Bore (2X)
7489	Small Bell Clamp 3.62" - 1" Bore
7490	Small Bell Clamp 4 1/2" - 1" Bore (2X)



Economy Modern Adapter System (EMAS) Set 1" Bore (12 parts)

SKU: 3000C

Includes:

MT-RSR Part #	Description
3001	5 1/4" Adapter Plate 1" Bore
3002	5 1/4" Front Cup with Spring 1" Bore
3003	Cone 1" Bore - Range 1.187" - 2.250"
3004	Cone 1" Bore - Range: 2.023" - 3.975"
7492	Self Aligning Spacer
5040	Spacer 1" Bore x 1" Length
5041	Spacer 1" Bore x 1 1/2" Length
3012	1" Bore Adapter Set for EMAs Foreign Vehicle (see below)
3007	7.55" Adapter Plate 1" Bore
5052	Cone 1" Bore - Range: 4 1/2" - 5 1/2"
5053	Cone 1" Bore - Range: 3.5" - 5 1/8"
5054	Cone 1" Bore - Range: 5" - 6 1/8"
3009	4" Front Plate for EMAs Foreign Vehicle
3014	Cone 1" Bore - Range: 5.875" - 7.875"
3015	Backing Plate 1" Bore 8" Offset Spacer
3016	Cone 1" Bore - Range: 6.875" - 8.10"

Basic EMAS Set 1" Bore Ammco, Rels, Hunter, Accuturn, Bosch

SKU: 3000

Includes:



MT-RSR Part #	Description
3001	5 1/4" Adapter Plate 1" Bore
3002	5 1/4" Front Cup with Spring 1" Bore
7903	Cone 1" Bore - Range: 1.187" - 2.250"
3004	Cone 1" Bore - Range: 2.023" - 3.975"
7492	Self Aligning Spacer
5040	Spacer 1" Bore x 1" Length
5041	Spacer 1" Bore x 1 1/2" Length
5084	Spring for Adapter Cup

EMAS 1" Bore Adapter Set

SKU: 3012

Includes:

MT-RSR Part #	Description
3005	7" Adapter Plate 1" Bore
3006	7" Front Cup with Spring 1" Bore



Cone 1" Bore - Range: 7.578" - 8.125"

SKU: 30103

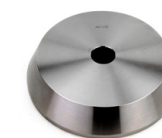

»» Quick Chucks



1" Double Chuck Adapter Set

SKU: 80040K

Interchangeable Part Numbers:

Ammco: 940921, W.Y. International: 80040K

MT-RSR Insights:

Ammco's exclusive Double Chuck Kit has 2 sets of concentric, expanding jaws to grip the center-hole and eliminate the need for cones. Passenger car jaws are permanently mounted on one side and truck jaws on the other side. No need to change jaws out. Fits all popular 1" arbor brake lathes. Handles virtually all hub-less drums and rotors (including composite) through 1 ton vehicles (Range: 2.125" - 5.75"). Choose from only 5 pieces to store and maintain. The weight and mass of the Double Chuck with Backing Plate virtually eliminates chatter and vibration from all hub-less applications, including composite drums and rotors. 75% fewer pieces means less maintenance and minimal replacement costs. Eliminates run-out and set-up problems with its self-centering feature.



Twin Chuck Kit

SKU: 8240

MT-RSR Insights:

The kit comes complete with two separate Quick Chucks one with standard jaws & standard plate and one with large jaws & large plate, plus small plate and Toyota plate. Key Features: No Jaws to change and optimal for shops with 2 or more brake lathes.



Large Jaw Set

SKU: 7041

Fits hub-less rotors & drums with centering holes from 3-3/4" to 5-3/4". Pair with 7040 Quick Chuck Adapter. The adapter's range is 2-1/4 to 3-3/4". This set expands that range to 2-1/4 to 5-3/4".



Quick Chuck Adapter

SKU: 7040

Interchangeable Part Numbers:

Ammco - 70042

MT-RSR Insights:

Do you machine a lot of rotors? This is the solution for you. This not only eliminates inventory but saves time and reduces setup errors. This quick chuck adapter is self-centering. Fits drums and rotors with centering holes from 2-1/4 to 3-3/4" for compact cars. With optional accessories, it can fit from 2-1/4 to 5-3/4" to include all vehicles up to 1 ton trucks.



Lite Dual Chuck Adapter Kit

SKU: 20040

Interchangeable Part Numbers:

Elite Enterprises 20040

MT-RSR Insights:

These aluminum chucks handle a range from 2 1/8" to 5 3/4" centering holes while only weighing 17 pounds for the complete kit. Aluminum makes this kit not only light, but immune to rust! No need to change jaws - Car jaws are on one side and truck jaws on the other side of the adapter.

»» Truck Sets



Truck Set 1" Bore - Range: 3 5/8" - 6 1/8" (5 pcs)

SKU: 5060

Interchangeable Part Numbers:

Ammco - 9399/9499, All Tool - 5589, Rels - 44710

Includes:

MT-RSR Part #	Description
5055	6 1/2" Diameter Bell Clamp - 1" Bore
5056-1	7 3/4" Diameter Bell Clamp - 1" Bore
5053	Cone 1" Bore - Range: 3.5" - 5 1/8"
5054	Cone 1" Bore - Range: 5" - 6 1/8"
5059	Heavy Duty Spring



Truck Set 1" Bore - Range: 4 1/2" - 5 1/2" (4 pcs)

SKU: 5061

Includes:

MT-RSR Part #	Description
5056-1	7 3/4" Diameter Bell Clamp - 1" Bore (2X)
5052	Cone 1" Bore - Range: 4 1/2" - 5 1/2"
5059	Heavy Duty Spring



Truck Set 1" Bore - Range: 3 5/8" - 5 1/8" (4 pcs)

SKU: 5062

Includes:

MT-RSR Part #	Description
5053	Cone 1" Bore - Range: 3 1/2" - 5 1/8"
5055	6 1/2" Diameter Bell Clamp - 1" Bore (X2)
5059	Heavy Duty Spring



Special Truck Set 1" Bore - Range: 4 1/2" - 5 1/2" (4 pcs)

SKU: 5063

Includes:

MT-RSR Part #	Description
5052	Cone 1" Bore - Range: 4 1/2" - 5 1/2"
5055	6 1/2" Diameter Bell Clamp - 1" Bore
5056-1	7 3/4" Diameter Bell Clamp - 1" Bore
5059	Heavy Duty Spring



Truck Set 1" Bore - Range: 3 1/2" - 5 1/8" (4 pcs) (Replace 5511)

SKU: 5064

Includes:

MT-RSR Part #	Description
5053	Cone 1" Bore - Range: 3 1/2" - 5 1/8"
5055	6 1/2" Diameter Bell Clamp - 1" Bore
5056-1	7 3/4" Diameter Bell Clamp - 1" Bore
5059	Heavy Duty Spring



Truck Set 1" Bore - Range: 3 7/8" - 6 1/8" (6 pcs)

SKU: 5065

Interchangeable Part Numbers: Similar to Ammco # 9299

Includes:

MT-RSR Part #	Description
5054	Cone 1" Bore - Range: 5" - 8 1/8"
5053	Cone 1" Bore - Range: 3 1/2" - 5 1/8"
5055	6 1/2" Diameter Bell Clamp - 1" Bore (2X)
5056-1	7 3/4" Diameter Bell Clamp - 1" Bore
5059	Heavy Duty Spring



Truck Set 1" Bore - Range: 3.1/2" - 6.1/2" (5 pcs)

SKU: 5066

Includes:

MT-RSR Part #	Description
5053	Cone 1" Bore - Range: 3.5" - 5 1/8"
5052	Cone 1" Bore - Range: 4 1/2" - 5 1/2"
5055	6 1/2" Diameter Bell Clamp - 1" Bore (2X)
5059	Heavy Duty Spring



Truck Set for F250/750

SKU: 3025-1

Includes:

MT-RSR Part #	Description
5056-1	7 3/4" Bell Clamp
5052	4.50"-5.50" Cone
30105	5.60"-4.50" Cone
5059	Heavy Duty Spring



Large Truck Set

SKU: 3026-1

Available In:

Bore Size	1"	1 7/8"
Kit SKU Number	3026-1	3026-1 7/8
Range: Individual Part Numbers		
9.25" Bell Clamp (2X)	30084	30084-1 7/8
5.60"-4.50" Cone	30105	30105-1.875
Spring	5059	5059



Extra Large Truck Set

SKU: 3027-1

Available In:

Bore Size	1"	1 7/8"	2"
Kit SKU Number	3027-1	3027-1 7/8	3027-2
Range: Individual Part Numbers			
12" Bell clamp (2X)	30099	30099-1 7/8	30099-2
8.062" -9.593" Cone	30100	30100-1 7/8	30100-2
Spring	5059	5059	5059

»» Arbors & Inserts



Stub Arbor Set

SKU: 5239



All Tool 11/16" Arbor

SKU: 5544



Ammco 1" Arbor

SKU: 7101

Interchangeable Part Numbers:
Ammco # 903101



Ammco 11/16" Arbor Kit Set 6 Pcs.)

SKU: 7708

Includes: 7122, 7118, 7882, 7120, 7121, 7138
Interchangeable Part Numbers:
Ammco OEM # 903122



Hunter, Performance and All Tool 1" Arbor

SKU: 8500

Interchangeable Part Numbers:
All Tool: 5542, Performance: 8542
Hunter: RP8-9019



Hunter 1" Arbor

SKU: 97422



Van Norman, Quick Way 11/16" Arbor Set

SKU: 204041

Interchangeable Part Numbers:
Van Norman # 804-2049-41



Hoffmann and RJ West 1" Arbor

SKU: 5389

Interchangeable Part Numbers:
Hofmann: 201 Standard, 300, 350, 400, True, Cut
401, RJ West: 1115 Heavy Duty
Total Length: 10.5"



Performance or All Tool 11/16" Arbor Set

SKU: 5831



Ammco 11/16" Arbor

SKU: 7122



Ammco 11/16" Arbor Nut

SKU: 7882



Accu-Turn 1" Arbor

SKU: 8701

Interchangeable Part Numbers:
Accu-Turn # 433701



Hunter Arbor (smaller ends)

SKU: 97422-3



Van Norman / RELS 2" Arbor

SKU: 869186



Ammco Positive Rake Coated Carbide Bit/Insert (Pack of 10)

SKU: 6918

Interchangeable Part Numbers:
Ammco #: 3850, 3860



Kwikway and Snap On Positive Rake Bits (10/pack)

SKU: 7109

Pos Rake Bit for Kwikway models# BDL, CDL, NDL fits RTI models# BRC35 OEM# 91212, REL's model# 504 Swing Arm Lathe, Snap-On Models# BTK10A, Also fits some Ammco, Hunter Brake Lathes, 10 bits per pack



FMC/John Bean Positive Rake Standard Bits (10/pack) - 90488

SKU: 7487

Interchangeable Part Numbers:
FMC/John Bean (OCL): 91212, Hofmann # W139, Hoffman/RJ West 722-83-4, 505 On-Car-Lathe/RTI Style, FMC/John Bean: 90487 & 90788



Positive Rake Bit (10/pack)

SKU: 7681

Interchangeable Part Numbers:
Ammco # 7681-2, 7681-6, Hunter # 212-583-3, 5386



VN/Rels Inserts (10/pack)

SKU: 7687

Interchangeable Part Numbers:
Rels - 29687, Van Norman - 29687, 866561, 564



Accu-Turn Inserts (10/pack)

SKU: 7796

Interchangeable Part Numbers:
Accuturn: 433796



Accu-Turn Premium Inserts Accu-Turn (10/pack)

SKU: 7796P

Interchangeable Part Numbers:
OEM# 433796



Ammco/Hunter/John Bean/FMC 7914-10 Negative Rake Carbide Insert 10 Pack

SKU: 7914

Interchangeable Part Numbers:
Ammco #: 6914, John Bean #: 90817, Hunter #: 221-580-2, 221-617-2, 221580, Performance # 3331, Rels # 45001



Ammco Negative Rake Thick Carbide Brake Lathe Bits

SKU: 7914TH

Interchangeable Part Numbers:
Ammco: 906914



VN Right Hand Drum Bits (Packs of 10)

SKU: 24176

Interchangeable Part Numbers:
FMC/John Bean: 24176, Rels: 24176, Van Norman: 866562



VN Positive Rake Left Hand Drum Bit (Packs of 10)

SKU: 24209

Interchangeable Part Numbers:
Rels - 204, 205, 300, 302, Van Norman - 303, 304, 305, 404, 405



Pro-Cut Positive Rake Bits for 50695 (Pack of 10)

SKU: 50742

OEM# 50742: also Fits VGB On Car Models# BTK10A, 10 bits per box



FMC/John Bean 0.048" Radius Positive Rake Bits (10 Pack)

SKU: 90327

Interchangeable Part Numbers:
FMC/John Bean #: 90327

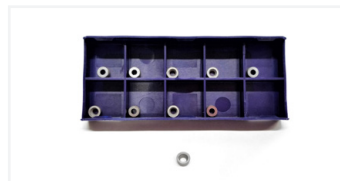

Hunter Micro Bits (Pack of 10)

SKU: 2216263

Interchangeable Part Numbers:
OEM# 2216263, Micro Round 10 bits per Pack. Use with MI7556 Screws



Ammco/Kwikway/Snap On Round Positive Rake Bits (Pack of 10)

SKU: CB69

Interchangeable Part Numbers:
Kwikway/Snap On: 0066



MI7556 Screw for Hunter Round bit

SKU: MI7556

For 2216263 bits

»» Tools Holders



RH Negative Tool Bit Holder

SKU: 7701

Interchangeable Part Numbers:
Ammco # 910701
Use with insert 7914



Ammco Short Negative Drum Tool Holder (Negative Rake)

SKU: 7872S

MT-RSR Insights:
Use with Insert 7914



Ammco Negative Drum Tool Holder (Positive Rake)

SKU: 7872P



Torque Wrench for Mini Screw

SKU: 2216282

For MI7556 screws



Accu-Turn and FMC Zero Angle Drum Tool Holder

SKU: 8286

MT-RSR Insights:
Use with Insert 7796 or 7796P



Accu-Turn and FMC R & L Right Hand Tool Holder

SKU: 9043

Includes: 9043L & 9043R
MT-RSR Insights:
Use with Insert CB69



Tool Holder for Accu-Turn and FMC - Right Hand

SKU: 9043R

Use with Insert CB69



LH Negative Tool Bit Holder

SKU: 7702

Interchangeable Part Numbers:
Ammco # 910702
Use with insert 7914



Ammco Negative Drum Tool Holder (Negative Rake)

SKU: 7872

Interchangeable Part Numbers:
Ammco # 9872, 909872
MT-RSR Insights: Use with Insert 7914



RH Positive Tool Holder

SKU: 7968

Interchangeable Part Numbers:
Snap-On # EEBR308A/309A
Use with insert 7681



Short Positive Rake Tool Holder

SKU: 7970

Interchangeable Part Numbers:
MT-RSR Insights:
Use with Insert 7914

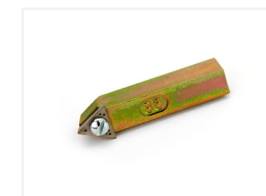

Accu-Turn and FMC Zero Angle Drum Tool Holder (Short Version)

SKU: 8286S

MT-RSR Insights:
Use with Insert 7796 or 7796P



Tool Holder for Accu-Turn and FMC - Left Hand

SKU: 9043L

Use with Insert CB69



Hunter LH & RH Round Tool Holder

SKU: 80337

Interchangeable Part Numbers:
Hunter # RP9-53980337
MT-RSR Insights:
Use with Insert 2216236



Hunter Round Tool Holder - Left Hand
SKU: 80337L
 Interchangeable Part Numbers:
 Hunter # RP9-53980337
 MT-RSR Insights:
 Use with Insert 2216263



Hunter Round Tool Holder - Right Hand
SKU: 80337R
 Interchangeable Part Numbers:
 Hunter # RP9-53980337
 Use with insert 2216263



RH & LH Round Bit Tool Holder Set Ammco 940630
SKU: BH69
 Includes: BH69R & BH68L
 Interchangeable Part Numbers:
 Ammco # 940630
 Use with insert CB69



Round Bit Tool Holder for Ammco - Left Hand
SKU: BH69L
 Use with insert CB69



Round Bit Tool Holder for Ammco - Right Hand
SKU: BH69R
 Use with insert CB69



Hold Down Clip for Round Inserts
SKU: BH69B
 MT-RSR Insights:
 Use with Insert BH69 & 9043



Ammco RH Tool Holder
SKU: 7651
 Interchangeable Part Numbers:
 Ammco OEM # 910651



Ammco LH Tool Holder
SKU: 7650
 Interchangeable Part Numbers:
 Ammco # 910650



Hunter , FMC, AMMCO , Curved Tool Holder Set

Interchangeable Part Numbers: Accuturn OEM: 434057 (left) and 434056 (right), All Tool OEM: 5587L (left) and 5589R (right), Ammco OEM: 90489 L & R, FMC/JB OEM : 8027165 (left) and 8027164 (right), Hunter OEM: 801-615-2 (left) and 801-616-2 (right), Hofmann OEM: W 209 (left) and W 209 (right), Performance OEM: 5587 (left) and 8589 (right), Accu-turn 434057, FMC 8027164 & Hunter RP8-8568

Available In:

MT-RSR Part #	Description
90489	Hunter , FMC, AMMCO, Curved Tool Holder Set
	Individual Part Numbers
90489R	Hunter , FMC, AMMCO, Curved Tool Holder - Right Hand
90489L	Hunter , FMC, AMMCO, Curved Tool Holder - Left Hand



Positive Tool Holder

Interchangeable Part Numbers: Long version: 8763L OEM #: Accu 433763, FMC 405, For rotors, drums, flywheels, and heavy-duty drums, 8764R OEM #: Accu 433764, FMC 404, For rotors and flywheels

MT-RSR Insights:

Comes with 7796 insert which is also available in a PREMIUM version: 7796P

Available In:

MT-RSR Part #	Description
8763R	Positive Tool Holder - Right Long
8764L	Positive Tool Holder - Left Long
8763RS	Positive Tool Holder - Right Short
8764LS	Positive Tool Holder - Left Short

»» Silencers



Ammco 6920 - Silencer Band - Ventilated - Lead free

SKU: 6030

Interchangeable Part Numbers:
 Ammco- 6920, FMC- 90084, Van Norman- 11148



Rotor Silencer Band- Fits Any Vented Rotor- Black Neoprene

SKU: 6030N



Universal Ventilated Rotor Silencer - Non Adjustable

SKU: 6031

Interchangeable Part Numbers:
 Accuturn # 434470



Large Ventilated Disc Rotor Silencer Range: 10-12" Diameter

SKU: 6032

Interchangeable Part Numbers:
 Accuturn # 433785

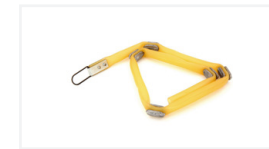

Adjustable Latex Tubing Ventilated Rotor Silencer

SKU: 6035



1 3/4" Drum Silencer Band for Automotive Drums (Length: 5'8") Ammco 5280

SKU: 6036



2 3/4" Truck Drum Silencer Band Extra Long (Length: 6') Ammco 5290

SKU: 6037

Interchangeable Part Numbers:
 Ammco # 5290



Solid Magnetic Rotor Silencer Band (0.25" x 4' - 6.35mm x 1219.2mm)

SKU: 6038



Small Black Solid Rotor Silencer Band for Use on Thin Rotors 6-9" (2 Pcs. pack)

SKU: 6039



Large Black Solid Rotor Silencer Band 10-12" diameter (2 Pcs. Pack)

SKU: 6040



Clip-On Disc Silencer

SKU: 6041A



Universal Clip On Silencer with Velcro hold on strap

SKU: 6042



Clip-on Silencer for Pro Cut Lathes Heavy Duty

SKU: 6045HD



Rotor Spring Silencer Assembly

SKU: 9800

Interchangeable Part Numbers:
 Ammco 9800 (Set of 4)

»» Kits



FMC Brake Lathe Rotor Feed Repair Kit

SKU: 6001

Includes:

MT-RSR Part #	Description
20494	Rotor Feed Detent Spring FMC
7487	Positive Rake Standard Bits for FMC (PK 10)
8077	Rotor Feed Nut for FMC
8071	Rotor Feed for FMC



Ammco Twin Cutter Assembly

SKU: 7950

Interchangeable Part Numbers: Ammco #: 6950

Includes:

MT-RSR Part #	Description
7920	Screw for Twin cutter (Not Sold Individually)
7650	LH Tool Holder Ammco
7651	RH Tool Holder Ammco
7584	New Style Brass for Twin Cutter from Ammco (2X)
7854	Red 3 Arm Knob for Ammco (2X)
7905	Return Spring for Twin Cutter (2X)
7910	Spring for Twin Cutter (2X)
7879	Locator Screw Ammco Twin Cutter (2X)
7909	Screw for Twin cutter Sq head (Not Sold Individually) (2X)
7900	Twin cutter Body(Not Sold Individually)
7911	1/4/20 Lock nut (Not Sold Individually) (2X)
7977	Plug (Not Sold Individually) (2X)
7901	Dial Assembly part of Ammco Twin Cutter (2X)

Shifter lever Assembly

SKU: 7742

Interchangeable Part Numbers: Ammco # 907742

Includes:



MT-RSR Part #	Description
7744	Shifter Lever Body for Ammco
7742-1	Shaft for Shifter Lever
7742-2	Knob for Shifter Lever (Not Sold Individually)
7742-3	Washer for Shifter Lever (Not Sold Individually)
7742-4	Retaining Ring for Shifter Lever 3/8 (Not Sold Individually)
7742-5	Spring for Shifter Lever (Not Sold Individually)

Ammco Repair Kit

SKU: 7099

Includes:



MT-RSR Part #	Description
7085	Spindle Boot for Ammco (2X)
7682	Brass Ring for Spindle Boot
7159	Snap Ring for Spindle Boot
7435	Wire Boot for Ammco (2X)
7854	Red 3 Arm Knob for Ammco (3X)
7142	5/16" Brass Plug Replacing Ammco 3142 (3X)



Ammco Brake Lathe Repair Kit

SKU: 90450

Includes:

MT-RSR Part #	Description
7836EA	Brass Plug for Ammco
7682	Brass Ring for Spindle Boot
6030	Natural Rubber Adjustable Ventilated Rotor Silencer Band - Fits Any Vented Rotor
6036	1 3/4" Drum Silencer Band for Automotive Drums (Length: 5'8")
7914	Negative Rake Bits (10/pk)
7854	Red 3 Arm Knob for Ammco (3X)
7085	Spindle Boot for Ammco
7996	Shear Gear for Ammco



Ammco 7075 Rotor Silencer-Assembly

SKU: 7075

Interchangeable Part Numbers: Ammco # 7075 , 907075

Includes:

MT-RSR Part #	Description
7075-1	SCREW, 3/8-16 (Not Sold Individually)
7079	Arm Rotor for 7075
7076	Slide Rotor for 7075
7075-4	SOC HD CS, 3/8- (Not Sold Individually)
7075-6	12" Rod
7080EA	Clip Rotor for 7075 (Pack Of 2)
7075-5	SCREW, 5/16-18 (Not Sold Individually)
7075-2	METAL SCREW (Not Sold Individually)
7077	Swivel Damper for 7075
7078	Lever Rotor for 7075
7079P	5/32 X 5/8 SPRING (Not Sold Individually)
7075-3	WRENCH, 3/8 (Not Sold Individually)
7183	Pads for Silencer 7075 (Set of 2)

Ammco Coupling Assembly

SKU: 7821

Interchangeable Part Numbers: Ammco # 909821

Includes:



MT-RSR Part #	Description
29822-1	Repair Part for Right Angle Gear Drive 9815 (Not Sold Individually)
7821D	Dowel Pin (Not Sold Individually)
7821S	External Retaining Ring 3/4 OD (Not Sold Individually)
7825	Roller Coupler part of 7821
7826	Gear Shaft (Not Sold Individually)



Ammco Cross Feed Extension Plate Kit

SKU: 7936

Interchangeable Part Numbers: Ammco # 6936

Includes:

MT-RSR Part #	Description
7936MC	Plate (Not Sold Individually)
6937	Flat Head Socket C (Not Sold Individually)
6938	Flat Head Socket H (Not Sold Individually)
7222	Longer Stud for 7936
6940	5/16" Long Allen Wrench Part of 7936
7227	Hold Down Nut



Ammco Right Angle Drive

SKU: 9815

Interchangeable Part Numbers: Ammco # 909815

Includes:

MT-RSR Part #	Description
9815M	Right Angle Drive Machine Housing (Not Sold Individually)
9815-1	Needle Roller Bearing (Not Sold Individually) (2X)
9815-2	Thrust Race 815 RT Drive (Not Sold Individually) (4X)
9815-3	Retaining Ring 1/2 Shaft Side Mount (Not Sold Individually) (2X)
9815-4	1-3/8 Hole Plug for RT Drive (Not Sold Individually)
77997	Worm Drive for Ammco
7821	Coupling Assembly for Ammco
7996	Shear Gear for Ammco
7821B	Brass Bushing
9815-5	10-24 x 1/4 Set Screw (Not Sold Individually) (2X)



Ammco Trap Assembly

SKU: 7757

Interchangeable Part Numbers: Ammco # 940718

Includes:

MT-RSR Part #	Description
4774	Gear for Trap Assembly
77774	Drive Rod for Ammco
7775	Gear Support for Ammco
7757-1	Socket Head Cap Screw 10-24 x 5/16 (Not Sold Individually) (2X)
7757-2	Spring Pin 1/8 x 5/8 (Not Sold Individually)
7757-3	Flat Washer 3/8 x .03/Thick (Not Sold Individually)
7757-4	Socket Head Cap Screw 10/24 x 5/8 (Not Sold Individually)
7757-5	Flat Washer 3/8 x .06 Thick (Not Sold Individually)
7757-6	Dowel Pin 3mm x 6mm (Not Sold Individually) (2X)
7757-7	Spacer OD x 1/8 Length for 10# Screw (Not Sold Individually)



Shafts/Studs/Rods



#	MT-RSR Part Number	Description	Interchangeable Part Numbers:
1	7031	Ammco Short Stud	Ammco # 903031
2	7084	Ammco Knurled Knob	Ammco # 903084
3	7211	Ammco Lead Screw 903211-1	Ammco 903211-1
4	7318	Ammco Lead Screw # 909918	Ammco # 909918
5	7337	Shaft for Ammco Adjusting Rod	Ammco part # 910337
6	7913	Ammco Stud	
7	7918	Ammco Drum Lead Screw	Ammco # 909918
8	7919	Ammco Drum Lead Screw (Longer version)	Ammco # 909919
9	8156	Accu-Turn Rotor Feed Screw	Accu-Turn #433156
10	8157	Accu-Turn Drum Feed Screw	Accu-Turn #433157
11	8667	FMC Drum Feed Screw	FMC # 90667
12	8670	FMC Hex Drive Rod	FMC # 90070
13	77748	Ammco Shifter Shaft	Ammco # 907748
14	77755	Ammco Shaft	
15	77997	Ammco Worm Drive	Ammco # 907997
16	8760	Accu-Turn Adjustment Screw	

Pulleys



Ammco Small Drive Pulley

SKU: 7024

Interchangeable Part Numbers:
Ammco OEM # 903024

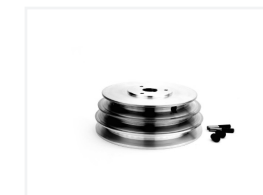

Large Pulley and Pin for Ammco

SKU: 7784-1

Interchangeable Part Numbers:
Ammco # 907784-1



Steel Pulley Set with Belt - Ammco

SKU: 7175

Includes: 21894-0008A, 21894-0007A, 7175AL-B,
7175SS



Aluminum Pulley Set with Belt - Ammco

SKU: 7175AL

Includes: 21894-0008A, 21894-0007A, 7175AL-B,
7175SS



»» Spacers



Repair Bushing for 7324 Ammco
SKU: 3036



Spacer 1" Bore X 1 1/2" Length
SKU: 5041



1 7/8" X 3" Spacer
SKU: 5085
Interchangeable Part Numbers:
Accuturn # 434645



1 7/8" X 1" Spacer
SKU: 5087
Interchangeable Part Numbers:
Accuturn # 434647



Spacer 1 1/16" Bore and 1/2" length
SKU: 7120



Spacer 1" Bore and 1/2" Length
SKU: 7125



Spacer 1" Bore X 1" Length
SKU: 5040



Spacer 1" Bore X 2" Length
SKU: 5042



1 7/8" X 2" Spacer
SKU: 5086
Interchangeable Part Numbers:
Accuturn # 434646



F150 Rotor Adapter 1" Bore (3 Pcs.)
SKU: 5532



Spacer 1 1/16" Bore and 1" length
SKU: 7121



Self-Aligning Spacer Ammco, Rels, Bosch, Hunter 9492
SKU: 7492
Interchangeable Part Numbers:
Ammco # 9472

»» Arbor Nuts



Ammco Arbor Nut for 7101 Arbor
SKU: 7102
Interchangeable Part Numbers:
Ammco # 903102



VN Nut for 2" Arbor 869186
SKU: 869190N

»» Guide Bar / Boring Bar



Ammco Upper Clamp
SKU: 2017
Interchangeable Part Numbers:
Ammco # 903017



Ammco Lower Clamp
SKU: 2066
Interchangeable Part Numbers:
Ammco # 920666



Ammco Standard Boring Bar
SKU: 7843
Interchangeable Part Numbers:
Ammco # 905843



Ammco 4100 Long Boring Bar
SKU: 7844
Interchangeable Part Numbers:
Ammco # 905844



Ammco Guide Bar for Extending Slides
SKU: 70346
Interchangeable Part Numbers:
Ammco # 910346

»» Lead Screw Nuts / Feed Screw Nuts

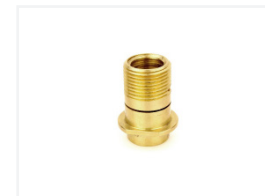

Ammco Lead Screw
SKU: 7670
Interchangeable Part Numbers:
Ammco 904670



Ammco Lead screw Nut
SKU: 7868
Interchangeable Part Numbers:
Ammco OEM #10868

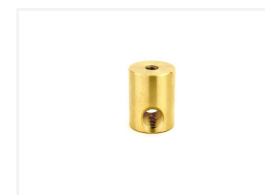

Accu-Turn Rotor Feed Nut
SKU: 8647
Interchangeable Part Numbers:
Accu-Turn Part #433647



Drum Feed Nut For FMC / John Bean 601 701 Brake Lathe 1016845
SKU: 8845
Interchangeable Part Numbers:
1016845



Ammco Lead Nut (New Longer Version)
SKU: 7712
Interchangeable Part Numbers:
Ammco # 907712

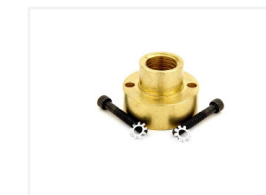

Ammco Lead Screw Nut
SKU: 7868X
Interchangeable Part Numbers:
Ammco OEM #10686X
Use with 7211 lead screw

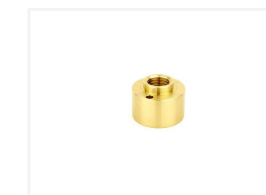

Ammco New Lead Screw Nut
SKU: 78529
Interchangeable Part Numbers:
Ammco # 928529

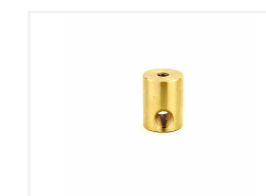

Accu-Turn Drum Feed Nut
SKU: 8646

BRAKE LATHES

AFTER MARKET REPLACEMENT PARTS



MSI EQUIPMENT

»» Boots & Belts



Feed Screw Boot for Ammco

SKU: 7086

Interchangeable Part Numbers:
Ammco # 903086



Ammco 3085 Protective Boot Spindle

SKU: 7085

Interchangeable Part Numbers:
Ammco # 903085



Ammco Cross Feed Boot

SKU: 7087

Interchangeable Part Numbers:
Ammco # 9030871



Ammco Boot

SKU: 7703

Interchangeable Part Numbers:
Ammco # 907703



Ammco V Belt

SKU: 7161

Interchangeable Part Numbers:
Ammco # 903161



Ammco Cogged V Belt

SKU: 7161COG

Interchangeable Part Numbers:
Ammco: VB31610007

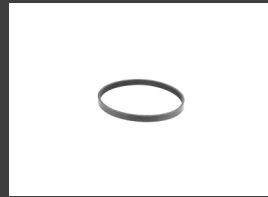

Ammco 20" Belt for 2 step 2 Spindle pulley.

SKU: 7175AL-B

Interchangeable Part Numbers:
Ammco Brake lathe part # 940141

»» Motors & Gears



Ammco 1 HP Motor

SKU: 7168

Interchangeable Part Numbers:
Ammco # 902165



Van Norman/Kwik-Way Brake Lathe Motor

SKU: 20488

Interchangeable Part Numbers:
Van Norman # 804-1405-25

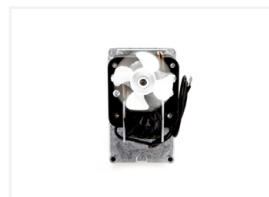

Accuturn Feed Motor for Brake Lathes 1/60 HP 6 RPM 120 Volt, 60 Hz, 1.5 Amps (Includes Fan)

SKU: 433641

Interchangeable Part Numbers:
Accuturn 433641



Accu-Turn Truck Lathe Variable Speed Motor

SKU: 436116

Interchangeable Part Numbers:
Accuturn # 4336116

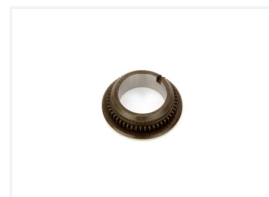

Ammco Friction Disc 903077

SKU: 7377

Interchangeable Part Numbers:
Ammco 903077



Ammco Friction Gear Replacement 903078

SKU: 7378

Interchangeable Part Numbers:
Ammco # 903078



Ammco Friction Disc Gear

SKU: 7381

Interchangeable Part Numbers:
OEM: 903081



Ammco Sliding Friction Gear

SKU: 73082

Interchangeable Part Numbers:
Ammco # 903082

»» MISC



Ammco Shift Lever

SKU: 3042

Interchangeable Part Numbers:
Ammco # 903042



Fan for 433641

SKU: 4135



Spanner Wrench Set for 5000 series

SKU: 5005



Micrometer

SKU: 6201

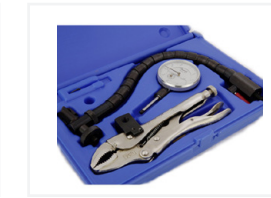

Runout Gauge

SKU: 6410

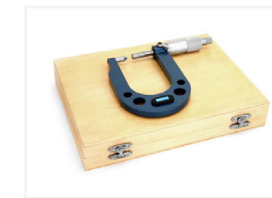

Micrometer

SKU: 72234202



DIGITAL Micrometer

SKU: 72234222

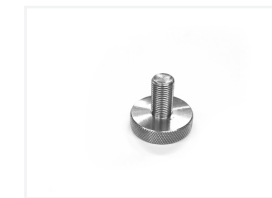

FMC Threaded Knob

SKU: 66704



Ammco Motor Mount Bracket with Hardware

SKU: 7009

Interchangeable Part Numbers:
Ammco # 3009



Ammco Wrench 1 1/4" x 1 1/16"

SKU: 7022



Brass Thrust Washer for Quill Drive Gear

SKU: 7033

Interchangeable Part Numbers:
Ammco # 903033, 40030



Ammco Shifter Clutch

SKU: 7058

Interchangeable Part Numbers:
Ammco # 903058

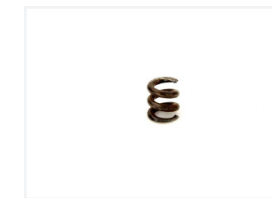

Ammco Cross Feed Spring

SKU: 7064

Interchangeable Part Numbers:
Ammco # 902064



Spherical Washer

SKU: 7138

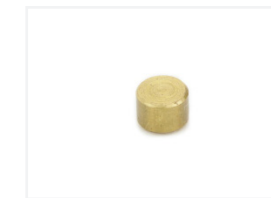

Ammco 3141 3/16" Brass Plug Replacement (Pack of 10)

SKU: 7141



Ammco Spherical Washer

SKU: 7165



Ammco Feed Control Lever

SKU: 7324

Interchangeable Part Numbers:
Ammco # 907343



Ammco Thrust Bearing Race 929220

SKU: 7220

Interchangeable Part Numbers:
Ammco: 929220



Ammco Thrust Bearing 929221

SKU: 7221

Interchangeable Part Numbers:
Ammco: 929221



Bearing and Washer for 7211

SKU: 7211A

BRAKE LATHES

AFTER MARKET REPLACEMENT PARTS



MSI EQUIPMENT



Ammco Wrench 3/8"

SKU: 7218



Ammco Rubber Spindle Boot

SKU: 7401

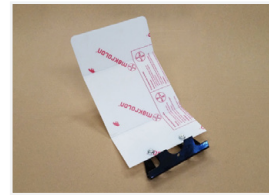

Ammco Chip Shield

SKU: 7481

Interchangeable Part Numbers:
Ammco # 9481



Rubber Connector for 7492

SKU: 7492R

Replacement part for: 7492



Ammco Rear Clamp

SKU: 7592

Interchangeable Part Numbers:
Ammco # 909592



Ammco Coupling Replacement

SKU: 47719

Interchangeable Part Numbers:
Ammco Part # 940717



Spindle Quill Gear

SKU: 70830

Interchangeable Part Numbers:
Ammco : Part # 909830 / 9830



Hex Shaft for FMC

SKU: 90082



FMC Hex Shaft Assembly

SKU: 90686

Interchangeable Part Numbers:
FMC - 90686



Accu-Turn Cogged Belt

SKU: 433673



Ammco Index Plate for (Pack of 10)

SKU: 7747

Interchangeable Part Numbers:
Ammco 907747



Step Adapter Takes 1 7/8 Bore down to 1 Bore (Set of 3)

SKU: 7790

Interchangeable Part Numbers:
Accuturn # 434472
Ammco # 904790



Ammco Disc Drive #9818

SKU: 7818

Interchangeable Part Numbers:
Ammco # 9818



Ammco On/Off Toggle Switch

SKU: 7893

Interchangeable Part Numbers:
Ammco # 906893



Ammco Work Light Brake Lathes

SKU: 7963

Interchangeable Part Numbers:
Ammco # 907963



Accu-Turn 4 Pole Switch

SKU: 433693



Washer for 204241

SKU: 204240



Poly V-Belt

SKU: J-240B



Ammco Seal

SKU: OS3163

Interchangeable Part Numbers:
Ammco OEM: 903163



Ammco Seal

SKU: OS3164

Interchangeable Part Numbers:
Ammco # 903164



Ammco Red Cap

SKU: 7974

Interchangeable Part Numbers:
Ammco # 906974



Accu-Turn T-Bolt 204079

SKU: 8633

Interchangeable Part Numbers:
204079 T-slot Bolt



T Bolt for Accu-Turn (Long)

SKU: 8633Long



Accu-Turn Way Cover Spacer

SKU: 8682



Accu-Turn Alignment Washer Set of 2

SKU: 83715



5/16" X 3/8" WR

SKU: WR3218



Micrometer Repair Screw

SKU: 1016776



Ammco 3142 5/16" Brass Plug Replacement (Pack of 10)

SKU: 7142

Interchangeable Part Numbers:
Ammco # 903142



Ammco Brass Plug (Pack of 10)

SKU: 7836

Interchangeable Part Numbers:
Ammco Part # 909836



Accu-Turn Way Cover

SKU: 8735

Interchangeable Part Numbers:
OEM #433735



Accu-Turn Way Cover Wiper Set of 3

SKU: 8736



Shaft and gear part of Coupling Assembly for Ammco

SKU: 9822



VN, Accu-Turn, FMC Arbor Nut

SKU: 20474

Interchangeable Part Numbers:
Accu-turn: 433713



Crank Handle for hand wheel

SKU: 23026

Interchangeable Part Numbers:
Ammco # 903026

05

WHEEL BALANCING

Replacement parts and accessories for most brands of wheel balancer. From our made-in-house pin plate and collet set to our selection of adhesive wheel weights, we have everything you need to get wheels balanced right so that every customer is satisfied. A variety of parts for 28 mm, 36 mm, 38mm, 40mm and 1-inch shafts.

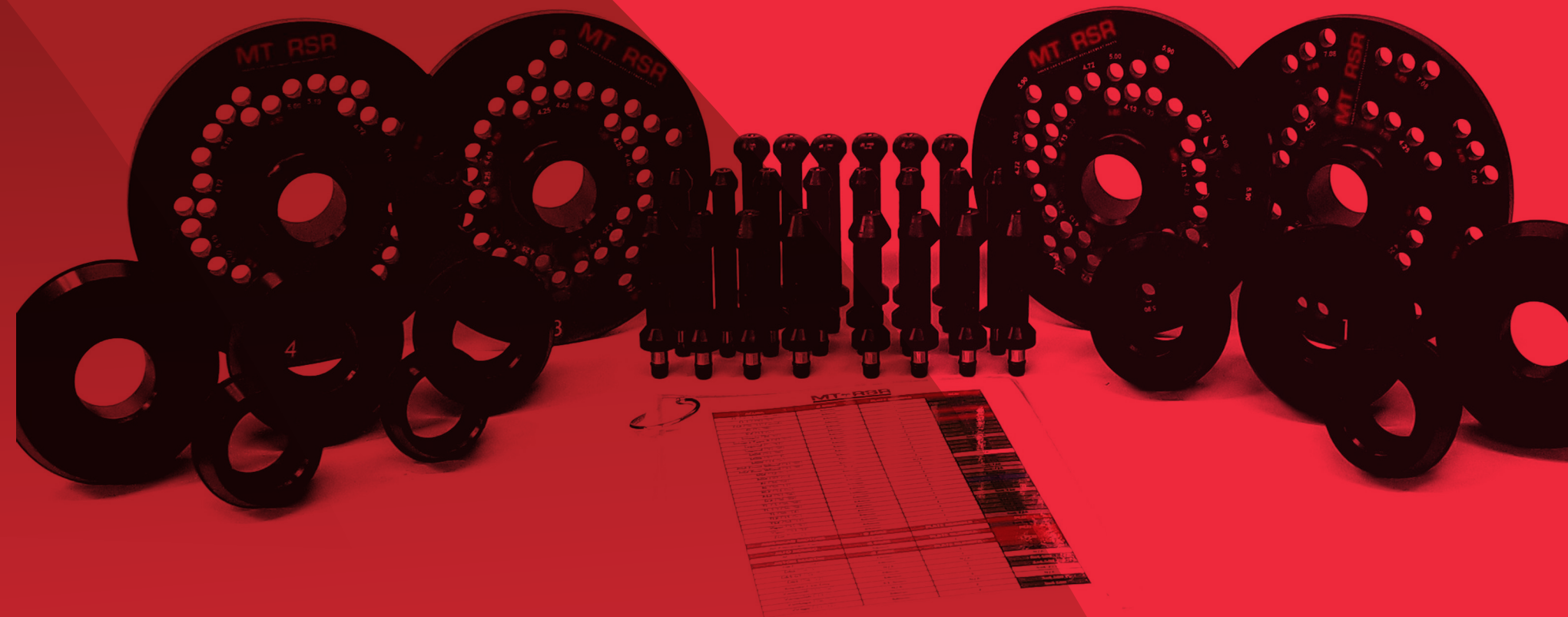

»» Cones & Backing Plates

MADE IN AMERICA



Pin Plate and Collet Set for Wheel Balancer

SKU: 4030-40

MT-RSR Insights:
MT-RSR is now offering a pin plate system with collet set. Most people would agree that the key to balancing any tire is to make sure that it is centered. With the old method of cone and pressure cup you are relying on the hub for centering. With the pin plate system, you are using the lug holes to center. This will avoid misalignment by improper and inconsistent mounting on the balancer. Our kit includes 4 plates with pins and the reference chart. The system is also Made in the USA and Precision machined. When you buy a set of 9 you can use them on a wide range of wheels. If you are having a problem balancing clad wheels, these are the solution! The dual sided design keeps it from bottoming out.

MT-RSR Part Number	Description
4021-40	Pin Plate #1
4022-40	Pin Plate #2
4023-40	Pin Plate #3
4024-40	Pin Plate #4
4025	Wide taper Stud (A) for pin plate 3.2 Long"
4026	Small Taper Stud (B) for pin plate 3.7" Long
4027	Round top Stud (C) for pin plate 4.1" Long
4029	Reference chart for Pin Plate system
3101-40	Low Taper Collet 2.00"-2.30" #1
3102-40	Low Taper Collet 2.30"-2.60" #2
3103-40	Low Taper Collet 2.60"-2.90" #3
3104-40	Low Taper Collet 2.90"-3.20" #4
3105-40	Low Taper Collet 3.20"-3.50" #5
3106-40	Low Taper Collet 3.50"-3.80" #6
3107-40	Low Taper Collet 3.80"-4.10" #7
3108-40	Low Taper Collet 4.10"-4.40" #8
3109-40	Low Taper Collet 4.40"-4.70" #9



40mm Wheel Balancer Flange Plate Kit

SKU: 4020-40

Interchangeable Part Numbers: Similar to: Snap-On # -1A, Corghi # 900200400A, Haweka # WB4029-40, Coats # 8113841, Hunter # 20-2123-2

MT-RSR Insights:
MT-RSR is now offering a pin plate system. Most people would agree that the key to balancing any tire is to make sure that it is centered. With the old method of cone and pressure cup you are relying on the hub for centering. With the pin plate system, you are using the lug holes to center. This will avoid misalignment by improper and inconsistent mounting on the balancer. Our kit includes 4 plates with pins and the reference chart.

Includes:

MT-RSR Part Number	Description
4021-40	Pin Plate #1
4022-40	Pin Plate #2
4023-40	Pin Plate #3
4024-40	Pin Plate #4
4025	Wide taper Stud (A) for pin plate 3.2 Long"
4026	Small Taper Stud (B) for pin plate 3.7" Long
4027	Round top Stud (C) for pin plate 4.1" Long
4029	Reference chart for Pin Plate system



Low Tapered Collet Set

SKU: 3100-40

Interchangeable Part Numbers: Similar to: Haweka # 51425, Snap-on # EEWB3-4, John Bean # EAK0315G93A, Hunter # 20-1846-1, Coats # 85609499

MT-RSR Insights:
These Collets are made in the USA and Precision machined. When you buy a set of 9 you can use them on a wide range of wheels. If you are having a problem balancing clad wheels, these are the solution! The dual sided design keeps it from bottoming out.

Includes:

MT-RSR Part Number	Description
3101-40	Low Taper Collet 2.00"-2.30" #1
3102-40	Low Taper Collet 2.30"-2.60" #2
3103-40	Low Taper Collet 2.60"-2.90" #3
3104-40	Low Taper Collet 2.90"-3.20" #4
3105-40	Low Taper Collet 3.20"-3.50" #5
3106-40	Low Taper Collet 3.50"-3.80" #6
3107-40	Low Taper Collet 3.80"-4.10" #7
3108-40	Low Taper Collet 4.10"-4.40" #8
3109-40	Low Taper Collet 4.40"-4.70" #9

WHEEL BALANCING

AFTER MARKET REPLACEMENT PARTS

28mm Shaft Models: Accuturn: 5100, 5223, 5500, 5600 (Serial #51-0001 To 51-0622), Coats: 700, 800, 825, 850, 925, 950, 1000, 1025, 1050 And 1250 IBS2000 (Shaft Must Be Verified 28mm) And 6200HS, Mondolfo, Ferro: All Models Excluding Truck Balancers, Norton: All Models, Snap-On: Shafts Must Be Verified 28mm, Sun: 1742 And 1762

36mm Shaft Models: Accuturn: 6100, 6600, 6800, Cemb: Pre 1995 Models, Coseng: C301, C311, C322, C366, Launch: 402, 412, Ranger: All Models

40mm Shaft Models: Accuturn: 1200, 1220, 1250, 1400, 1420, 1450, 1500, 1520, 1550, 1650, 1820, 1850 (5100, 5323, 5500, 5600 With Serial #Is 51-0623 To 51-1457), Bear: 80-100, 80-303, Beisbarth: All Models, Bosch: All Models, CEMB: All Models 1995 And Later, (Excluding Truck Models), Coats: (Previously Upgraded to 40mm Shafts) 700, 800, 825, 850, 925, 950, 1000, 1025, 1050, 1055, 1250, IBS 2000 (Shaft Must Be Verified 40mm), 1750, 1800, 1850, 775, 875, 1175, 6275HS, XR Balancers, Corghi: All Models 2007 And Later, FMC: All Models, Hofmann: All Models, Hunter: All Models, John Bean: All Models, Kwikway: All Models, Launch: 408, 500, Snap-On: Shaft Must Be Verified 40mm, Sicam: All Models

All Cones Sold Individually



SKU: 2415-28

Wheel Balancer 4 Cones System Set - Range: 1.75" - 5.25"

Available In The Following Sizes:

Bore Size	28mm	36mm	38mm	40mm
Kit SKU Number	2415-28	2415-36	2415-38	2415-40
Range: Individual Part Numbers				
1.75" - 2.75" Cone	2410	8476-36	8476-38	8476-40
2.44" - 3.06" Cone	2411	8253-36	8253-38	8253-40
2.95" - 3.63" Cone	2412	8252-36	8252-38	8252-40
3.375" - 5.25" Cone	2095-28	2095-36	2095-38	2095-40
Spring	8820-28	8825	8825	8825



SKU: 2057-28

Balancer Cone Set (Range: 5.03" to 6.88") and 7" Offset Spacer

Available In The Following Sizes:

Bore Size	28mm	36mm	38mm	40mm
Kit SKU Number	2057-28	2057-36	2057-38	2057-40
Range: Individual Part Numbers				
7" Backing Plate	2058-28	2058-36	2058-38	2058-40
5.03" - 6.88" Cone	2059-28	2059-36	2059-38	2059-40



SKU: 2409-28

Wheel Balancer 3 Cones System Set - Range 1.75" - 3.63"

Available In The Following Sizes:

Bore Size	28mm	36mm	38mm	40mm
Kit SKU Number	2409-28	2409-36	2409-38	2409-40
Range: Individual Part Numbers				
1.75" - 2.75" Cone	2410	8476-36	8476-38	8476-40
2.44" - 3.06" Cone	2411	8253-36	8253-38	8253-40
2.95" - 3.63" Cone	2412	8252-36	8252-38	8252-40
Spring	8820-28	8825	8825	8825



SKU: 2061-28

Balancer Cone Set - Range: 5.875" to 7.31" with 7" Offset Spacer

Available In The Following Sizes:

Bore Size	28mm	36mm	40mm
Kit SKU Number	2061-28	2061-36	2061-40
Range: Individual Part Numbers			
7" Backing Plate	2058-28	2058-36	2058-40
5.875"-7.31" Cone	2060-28	2060-36	2060-40



Low Profile Taper Balancer - Range 1.69" - 5.18" (Set of 7 pcs.)

SKU: 9250-28

Available In The Following Sizes:

Bore Size	28mm	36mm	40mm
Kit SKU Number	9250-28	9250-36	9250-40
Range: Individual Part Numbers			
1.69" - 2.23" Cone	9251-28	9251-36	9251-40
2.15" - 2.58" Cone	9252-28	9252-36	9252-40
2.50" - 2.94" Cone	9253-28	9253-36	9253-40
2.85" - 3.28" Cone	9254-28	9254-36	9254-40
3.20" - 3.63" Cone	9255-28	9255-36	9255-40
3.45" - 4.36" Cone	9256-28	9256-36	9256-40
4.24" - 5.18" Cone	9257-28	9257-36	9257-40

Balancer 4 Cones Set - Range: 1.169" - 3.28"

SKU: 9240-28

Available In The Following Sizes:

Bore Size	28mm	36MM	40mm
Kit SKU Number	9240-28		9240-40
Range: Individual Part Numbers			
1.69" - 2.23" Cone	9251-28	9251-36	9251-40
2.15" - 2.94" Cone	9252-28	9252-36	9252-40
2.50" - 2.94" Cone	9253-28	9253-36	9253-40
2.85" - 3.28" Cone	9254-28	9254-36	9254-40
Spring	8820-28	8825	8825



Conversion Wheel Balancer Shaft Converts 28 mm to 40 mm (Complete Kit)

SKU: 13080

Will Convert Coats Balancers:

700, 800, 825, 850, 925, 950, 1000, 1025, 1050 And 1250

MT-RSR Insights:

40mm Coats Wheel Balancer Conversion Shaft Kit Conversion Of 28mm To 40mm Coats Balancers (Includes: Shaft And Coupler). When upgrading to a 40mm shaft, this kit allows for more accurate balancing and saves time on the balancing process.

Includes:

MT-RSR Part Number	Description
13082	Conversion Wheel Balancer Shaft Converts 28MM to 40 mm (Only Shaft, Coupler)
812103	40 MM Hub Nut for Balancer Shaft with 8 MM Thread Pitch
10058	40 MM Pressure Cup
8476-40	Balancer Cone 40 MM Bore - Range 1.175" - 2.58"
8253-40	Balancer Cone 40 MM Bore - Range 2.44" - 3.06"
8252-40	Balancer Cone 40 MM Bore - Range 2.95" - 3.63"
2095-40	Balancer Cone 40 MM Bore - Range: of 3.375"-5.25"
8825	Cone Spring 36 or 38 or 40MM



Low Taper Collet 4.7"-4.9" #10

SKU: 3110-40

Interchangeable Part Numbers: Snap-On #EEWB3-51A

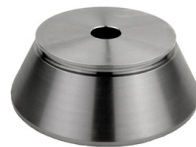

Balancer Cone - Range: 5.875"-7.31"

SKU: 2060-28

Available In The Following Sizes:

Bore Size	28mm	36mm	38mm	40mm
Range: 5.875"-7.31" 2060-28	2060-28	2060-36	2060-38	2060-40



Balancer Cone - Range: 3.375"-5.88"

SKU: 29069-28

Available In The Following Sizes:

Bore Size	28mm	36mm	38mm	40mm
Range: 3.375"-5.88"	29069-28	29069-36	29069-38	29069-40



Cone - Range: 5.875" - 7.000"

SKU: 3014-28

Available In The Following Sizes:

Bore Size	28mm	36mm	40mm
Range: 5.875" - 7.000"	3014-28	3014-36	3014-40

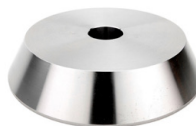

Balancer Cone - Range: 6.875"-8.10"

SKU: 3016-28

Available In The Following Sizes:

Bore Size	28mm	36mm	38mm	40mm
Range: 6.875"-8.10"	3016-28	3016-36	3016-38	3016-40



Balancer Adapter - Range 6.00"-7.00" Ford F450/F550

SKU: JF4/550-28

Available In The Following Sizes:

Bore Size	28mm	36mm	38mm	40mm
Range: 6.00"-7.00" Ford F450/F550	JF4/550-28	JF4/550-36	JF4/550-38	JF4/550-40

»» Hub Nuts, Shafts & Measurement Tools



40 MM Hub Nut for Balancer Shaft with 8 MM Thread Pitch

SKU: 812103

Interchangeable Part Numbers: Coats Part # 8112103, Hunter part # 76-432-1, 76-438-2



40 MM Hub Nut for Balancer Shaft with 4 MM Thread Pitch

SKU: 2374

Interchangeable Part Numbers: FMC 61072



38 MM Hub Nut for Balancer Shaft with 3 MM Thread Pitch

SKU: 2375



40MM X 4MM Quick Nut With Cup and Ring

SKU: 4040



Quick Nut Set for 36 MM Balancer Shaft with 3 MM Thread Pitch

SKU: 3630

Interchangeable Part Numbers: WBA363QNK, J143363003



Coats Small Pressure cup for 28 mm

SKU: 10542

Interchangeable Part Numbers: Replaces Coats "Pressure Drum" Part Number 8110542.



6" Rubber ring for pressure cup

SKU: 61572

Replaces Hunter Part 106-157-2



Coats 28 MM Hub Nut for Balancer Shaft with 8 MM Thread Pitch

SKU: 7543

Interchangeable Part Numbers: Coats #: 81105431, Coats #: 8110543, COATS Part #: 110543, HN11054



Special 38 MM Hub Nut

SKU: 23755



40mm X 3MM Quick Nut With Cup and Ring

SKU: 4030



Quick Nut Set for 40 MM Balancer Shaft with 8 MM Thread Pitch

SKU: 4080

Interchangeable Part Numbers: HW124408006, 20-1382



Hunter 4.5" Pressure Cup

SKU: H-753531



6" Pressure Cup & Ring..Pressure Cup - Hunter 175-3921. Ring - Hunter - 106-1572

SKU: 53921

Replaces Hunter 175-392-1



Rubber Ring for Balancer Cup 4.5"

SKU: 9383

WHEEL BALANCING

AFTER MARKET REPLACEMENT PARTS



MSI EQUIPMENT



Hunter Rubber Ring for Balancer Cup 4.5"

SKU: H-106822

Interchangeable Part Numbers:
Hunter 106-82-2, 106822,



FMC Balancer Shaft

SKU: 2373



Wheel Bolt Pattern Gauge Set Includes 15 Gauges, 2 Conical Adapters

SKU: TI79

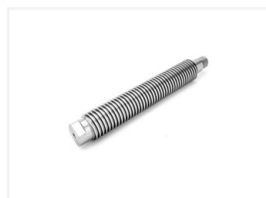

Accu-Turn & Coats Extended Shaft - 7" Thread Stub Shaft

SKU: 78167

Interchangeable Part Numbers:
8308171, 8113167C



Wheel Caliper

SKU: 30911



3M™ Replacement Kit PN61592, Replacement Anvil and Blades for 3M™ Universal Cutting Tool PN61479

SKU: 3M-61592



3M™ Wheel Weight Removal Tool PN99099

SKU: 3M-99099



Yellow Wheel Weight Scraper Removal Tool

SKU: 10-SCRAPER-Y



Wheel Weight Plastic Removal Tool/Scraper - Red

SKU: 10-9909



Metal Blade wheel weight removal tool/scraper - Blue Handle

SKU: 10-4459

»» Wheel Weights

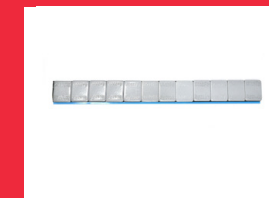

1/4 oz Gray Steel Adhesive Wheel Weights Low Profile

SKU: WW-FE-2552-GRY



1/4 oz Black Steel Adhesive Wheel Weight Low Profile

SKU: WW-FE-2552-BLK



1 oz Gray Steel Adhesive Wheel Weight Low Profile

SKU: WW-FE-0136-GRY



1/2 oz Black Steel Adhesive Wheel Weight Low Profile

SKU: WW-FE-5035-BLK

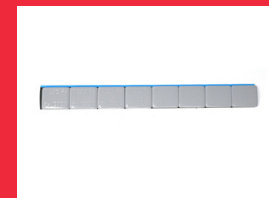

1/2 oz Gray Steel Adhesive Wheel Weight Low Profile

SKU: WW-FE-5035-GRY

»» 3M & Wheel Weights



3M™ Wheel Weight Starter Kit PN99100

SKU: 3M-99100



3M™ Wheel Weight Starter Kit PN99101

SKU: 3M-99101



3M™ Mechanical Replacement Weight PN99427, 7mm x 14mm

SKU: 3M-99427



3M™ Wheel Weight PN61405, 4mm x 23mm

SKU: 3M-61405



3M™ Wheel Weight TN6020, 20 mm x 6.0 mm, 14.0 M Roll, P/N 55428 Black

SKU: 3M-55428



3M™ Wheel Weight TN4715, 15 mm x 5.6 mm, 10.7 M Roll, P/N 61403

SKU: 3M-61403

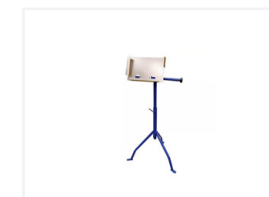

3M™ Wheel Weight Cutting Stand

SKU: 3M-61480



3M™ Dual Box Holder Kit PN99428

SKU: 3M-99428



3M™ Dual Cutter Bracket PN99429

SKU: 3M-99429



3M™ 61479 Universal Wheel Weight Cutting Assembly Tool With Measure

SKU: 3M-61479

»» UWT

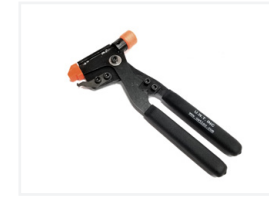

UWT Wheel Weight Pliers and Hammer

SKU: UWT-PLIERS



Wheel Weight Hammer/Removal Tool

SKU: UWT-1200HP



UWT Pliers Replacement Part Kit - Boot, Cap, and Hook

SKU: UWT-PL-RK



UWT Pliers Replacement Protector Boot

SKU: UWT-PL-2



UWT Pliers Replacement Cap

SKU: UWT-PL-1



UWT Replacement Hammer Cap for Wheel Weight Hammer/Removal Tool

SKU: UWT-1200-1



UWT Pliers Replacement Hook #42

SKU: UWT-PL-42



UWT Replacement Hook #72

SKU: UWT-900-72



UWT Replacement Hook #52

SKU: UWT-900-52

06

AUTO LIFT

Rubber lift pads to protect paint and grip cars. Check out our selection of lift pads for Alamo, Challenger, Forward, Quality, Western, BendPak, and more. Most pads are available to ship same day or next day.



»» Lift Pads



Alamo Rubber Arm Pad (Pack of 4)

SKU: 6501-4

Dimensions:
5.750 x 3.750



Challenger Rubber Arm Pad A11052x (Pack of 4)

SKU: 6503-4

Dimensions:
4.00" x 4.00" x .375"
Interchangeable Part Numbers:
OEM Ref.: A11052x, A1104x

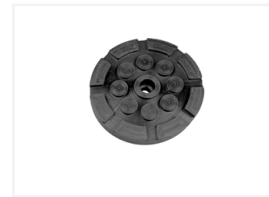

Quality Rubber Arm Pad (Pack of 4)

SKU: 6505-4

Dimensions:
Ø 4.750 x 1.000
Interchangeable Part Numbers:
OEM Ref.: 26K25030



Forward Rubber Arm Pad 5" x 5" x 3/8" (Pack of 4)

SKU: 6507-4

Dimensions:
5" x 5" x 3/8"
Interchangeable Part Numbers:
OEM Ref.: 994105x, 991234xc, 991222x



Globe/Ford Smith Rubber Arm Pad (Pack of 4)

SKU: 6509-4

Dimensions:
5" dia x 1"
Interchangeable Part Numbers:
OEM Ref.: 10.157



Rotary Rubber Arm Pad (Pack of 4)

SKU: 6511-4

Dimensions:
4 1/8" x 3 5/16" x 3/8"
Interchangeable Part Numbers:
OEM Ref.: FJ6213



Challenger Rubber Arm Pad 4" x 4" (Pack of 4)

SKU: 6502-4

Dimensions:
4" x 4" x 7/16"
Interchangeable Part Numbers:
OEM Ref.: A11052, A1104



Challenger Rubber Arm Pad B2208 (Pack of 4)

SKU: 6504-4

Dimensions:
Ø5.437 x Ø4.75
Interchangeable Part Numbers:
OEM Ref.: B2208 -



Forward Rubber Arm Pad 5" x 5" x 1/4" (Pack of 4)

SKU: 6506-4

Dimensions:
5" x 5" x 1/4"
Interchangeable Part Numbers:
OEM Ref.: 994105, 991234, 991222



Force Rubber Arm Pad (Pack of 4)

SKU: 6508-4

Dimensions:
Ø 4 9/16" x 1 1/16"
Interchangeable Part Numbers:
OEM Ref.: 90292, 90292-4



Rotary Rubber Arm Pad (Pack of 4)

SKU: 6510-4

Dimensions:
Ø 4.25 x .25
Interchangeable Part Numbers:
OEM Ref.: FJ6155-7



Western Rubber Arm Pad (Pack of 4)

SKU: 6512-4

Dimensions:
4 3/8" x 4 3/8" x 5/16"
Interchangeable Part Numbers:
OEM Ref.: S-2001



Western Rubber Arm Pad (Pack of 4)

SKU: 6513-4

Dimensions:
4 1/2" x 3 3/4" x 3/8"
Interchangeable Part Numbers:
OEM Ref.: S-2002



ALM Rubber Arm Pad (Pack of 4)

SKU: 6515-4

Interchangeable Part Numbers:
OEM: AMLP-0127
Pad is 6.25" round.



Western Rubber Arm Pad (Pack of 4)

SKU: 6517-4

Dimensions:
4"x4.5"x1" thick
Interchangeable Part Numbers:
OEM; S-350



Benwil & Bishamon Rubber Arm Pad (Pack of 4)

SKU: 6519-4

Dimensions:
5.750 x 3.750
Interchangeable Part Numbers:
OEM Number: 205175, SP710002, 100533 HD



Replacement Rubber Pad Kit

SKU: 6521-4

Dimensions:
4.75 in square 3/8 thick



BendPak Rubber Pad 5"

SKU: 6523-4

Fits Models:
BendPak Lifts
Comparable Part Numbers:
Bend-Pak 5715017, BH-7474-78-4
5" round



Heavy Duty Rubber Arm Pad Kit (Set of 4 Pads) - for Challenger Lifts

SKU: 6525-4

Overall Size (US Standard): 3-3/4" x 4-11/32" (3.75 in x 4.34 in)



Wheeltronic Rubber Arm Pad (Pack Of 4)

SKU: 6514-4

Dimensions:
4 13/16" x 7/8"
Interchangeable Part Numbers:
OEM Ref.: 6-2050



Challenger & VBM Rubber Arm Pad (Pack of 4)

SKU: 6516-4

Dimensions:
6 1/8" x 6 1/8" x 1/2"
Interchangeable Part Numbers:
OEM: 31057, 11052 & 200086



Ammco/Ben Pearson Rubber Arm Pad (Pack of 4)

SKU: 6518-4

Dimensions:
3 7/8" x 4 7/8" x 7/8"
Interchangeable Part Numbers:
Ammco OEM; 82365 & 91559



Bendpak Slip Over Rubber Arm Pad

SKU: 6520-4

Fits Models:
MX-12C MX-15C MX-18C All MX Models
5-5/8 Sq 1-1/16 thick



Lift Pad Kit - BendPak and Some Western

SKU: 6522-4

Dimensions:
3 7/8" x 4 7/8" x 7/8"



BendPak Rubber Pad Kit (1 pad with Bracket)

SKU: 6524-4

Fits Models:
BendPak & Some Western